

FIRE PROTECTION SYSTEMS CATALOG

Effective October 2017



 **ictaulic**[®]

ENGINEERING CONFIDENCE

INTO EVERY BUILD





Since 1919, Victaulic's pipe joining and flow control solutions have optimized construction productivity and reduced risk, ensuring projects are completed safely, on time and within budget. Driven by a spirit of continuous innovation, Victaulic's portfolio of 100,000+ products and patented technologies promote freedom of design, as well as simplified inspection and maintenance for the life of any system.

Look inside many of the world's most recognizable landmarks and industrial facilities, and you will find Victaulic solutions at work making bold innovations possible. From the tallest buildings to the deepest mines, customers trust our products to increase overall system durability in the most demanding construction projects and operating conditions.

From concept to commissioning, Victaulic provides innovative piping products and design services that helps engineer confidence into every build.

TABLE OF CONTENTS

1	VicFlex™ Sprinkler Fitting System
9	Couplings
17	Fittings
21	Innovative Groove System (IGS)
25	Hole Cut System
27	Valves and Accessories
35	Devices and Accessories
47	Hydraulic Control Valves
53	Automatic Sprinklers
67	Victaulic Vortex™
69	Specialty Systems
73	Pipe Preparation Tools
85	Design Data
88	Index

CONTINUING EDUCATION

Victaulic® offers a wide variety of continuing education courses. From one-hour seminars to full-day events, these courses provide education on key industry concepts and Victaulic solutions. Created for owners, engineers, contractors, the inspection community, and anyone else seeking to expand their knowledge of Victaulic and the industry surrounding the grooved pipe-joining and flow control markets.

For more information on the Victaulic Continuing Education Courses or to schedule your training, please contact your local sales representative or email us at: VictaulicUniversity@victaulic.com



CONSTRUCTION PIPING SERVICES

Drawing, BIM coordination and software solutions for the fire protection industry. Victaulic.com/resources-software offers an extensive library of CAD files and software product content created in each software's native platform.

Victaulic Tools for Revit® provide an intuitive set of tools that are purposely built to improve pipe routing and fabrication functionality in Revit® 2014 through 2018, including Fabrication Parts. It's specifically designed to meet the needs of engineers, contractors and pipe fabricators – giving you smarter tools to fabricate faster and route more efficiently. victaulicsoftware.com





















FASTER FROM THE STARTSM



VicFlex™ Sprinkler Fitting System

Victaulic offers a comprehensive portfolio of *VicFlex* sprinkler fitting systems, fully engineered and manufactured by Victaulic for consistent installation and performance. *VicFlex* sprinkler fitting systems offer confidence by providing 100% kink resistance and the tightest bends in the market. Up to 13x faster than threaded black pipe, *VicFlex* eliminates messy cutting tools and custom arm-over fabrication. The *VicFlex* system features brackets, hoses and fittings for a wide variety of sprinkler system applications including: commercial suspended ceilings, commercial metal or wood stud hard lid/drywall ceilings, block wall institutional spaces, clean room environments, or industrial duct systems.



Hoses	page	Brackets (Commercial Ceilings)	page
 <i>VicFlex</i> Braided Hose with Captured Coupling (Series AH2-CC)	2	 <i>VicFlex</i> Bracket (Style AB10)	6
 <i>VicFlex</i> Braided Hose (Series AH2)	2	 <i>VicFlex</i> Bracket (Style AB11)	6
 <i>VicFlex</i> Braided High Pressure Hose (Series AH2-300)	2	 <i>VicFlex</i> Bracket (Style AB12)	6
 <i>VicFlex</i> Braided Hose (Series AH1)	3	Specialty Systems page	
 <i>VicFlex</i> Corrugated Hose (Series AH5)	3	 <i>VicFlex</i> Dry Sprinkler (Style VS1)	7
Brackets (Commercial Ceilings) page		 <i>VicFlex</i> for Surface Mount (Style AB3)	7
 <i>VicFlex</i> Bracket (Style AB1)	3	 <i>VicFlex</i> for Cold Storage (Style AB6)	7
 <i>VicFlex</i> Bracket (Style AB2)	4	 <i>VicFlex</i> for Duct (Series AQD)	8
 <i>VicFlex</i> Bracket (Style AB4)	4	 <i>VicFlex</i> for Clean Rooms (Series AQC-U)	8
 <i>VicFlex</i> Bracket (Style AB5)	4	Accessories page	
 <i>VicFlex</i> Bracket (Style AB7)	5	 <i>VicFlex</i> Reducer Nipples and Elbows	8
 <i>VicFlex</i> Bracket (Style AB7 Adjustable)	5		
 <i>VicFlex</i> Bracket (Style AB8)	5		

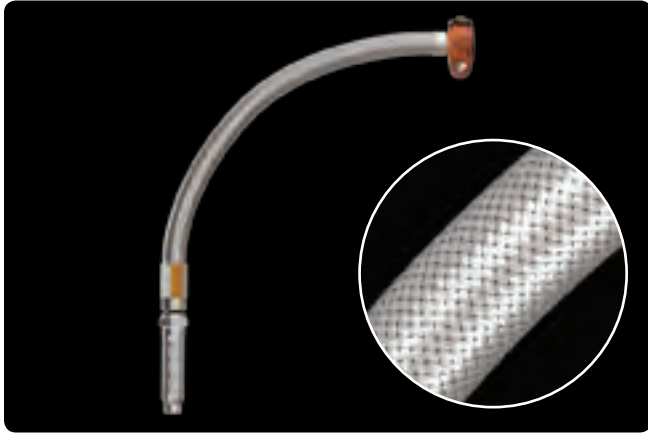

Certifications/Listings:



VicFlex™ Braided Hose with Captured Coupling

SERIES AH2-CC

[Download publication 10.85](#) for complete information

- Captured coupling technology; allows fast, safe installation and pad to pad visual confirmation
- Tightest bends available; 100% kink resistant
- For use on optimized IGS roll groove for 1" | DN25 pipe
- Minimum bend radius: cULus – 2" | 51 mm, FM – 7" | 178 mm, VdS – 3" | 76.2 mm
- Sizes 31 – 72" | 790 – 1830 mm
- Pressures up to 232 psi | 1600 kPa | 16 bar

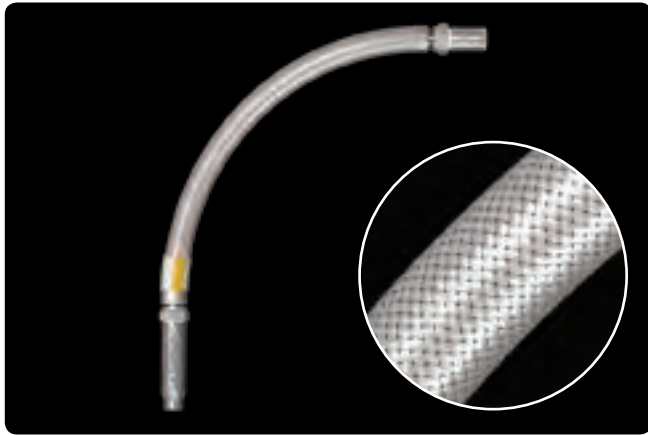

Certifications/Listings:



VicFlex™ Braided Hose

SERIES AH2

[Download publication 10.85](#) for complete information

- Tightest and most bends available in the industry
- Up to 10x faster than threaded black pipe, 100% kink resistant
- Minimum bend radius: cULus – 2" | 51 mm, FM – 7" | 178 mm, VdS/LPCB – 3" | 76.2 mm
- Sizes 31 – 72" | 790 – 1830 mm
- Pressures up to 232 psi | 1600 kPa | 16 bar

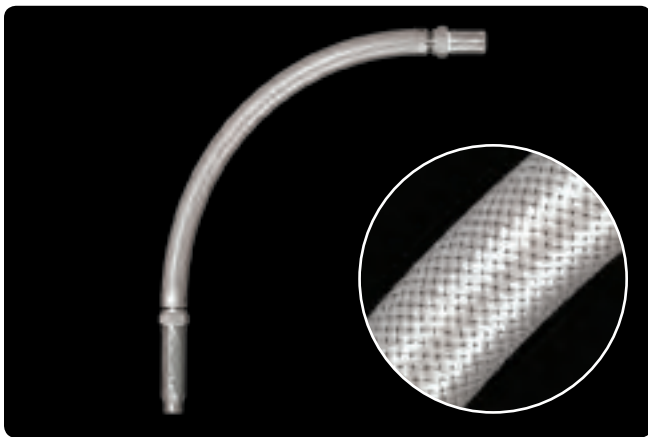

Certifications/Listings:



VicFlex™ Braided High Pressure Hose

SERIES AH2-300

[Download publication 10.84](#) for complete information

- High pressure hose; 100% Victaulic design and manufacturing
- Up to 10x faster than threaded black pipe, 100% kink resistant
- Minimum bend radius: FM – 7" | 178 mm
- Sizes 31 – 72" | 790 – 1830 mm
- Pressures up to 300 psi | 2068 kPa | 21 bar

VicFlex™ Sprinkler Fitting System

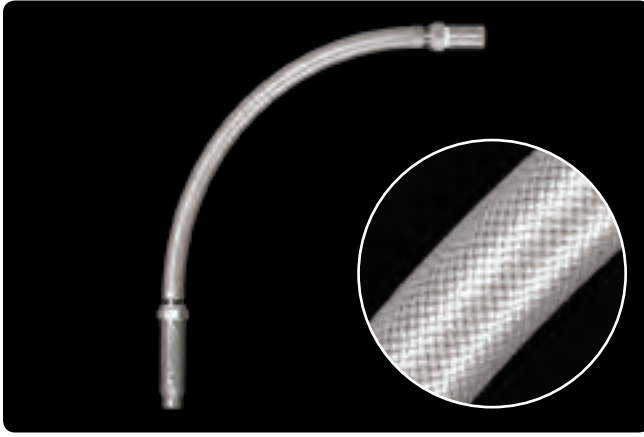

Certifications/Listings:



VicFlex™ Braided Hose

SERIES AH1

[Download publication 10.95](#) for complete information

- Flexible stainless steel hose, for use in suspended or hard-lid ceilings
- Up to 10× faster than threaded black pipe, 100% kink resistant
- Minimum bend radius: cULus – 3" | 76.2 mm, FM – 7" | 178 mm, VdS/LPCB – 3" | 76.2 mm
- Sizes 31 – 72" | 790 – 1830 mm
- Pressures up to 232 psi | 1600 kPa | 16 bar

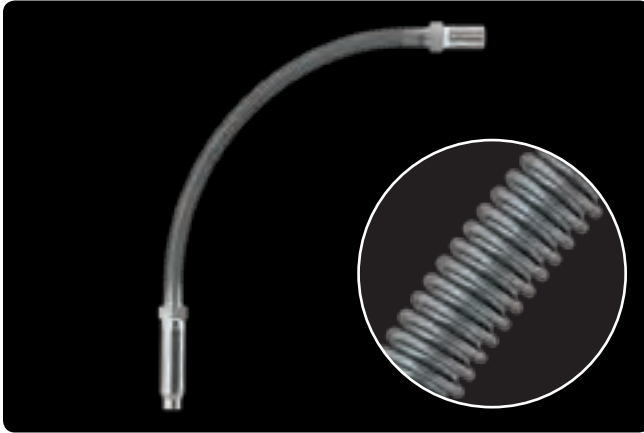

Certifications/Listings:



VicFlex™ Corrugated Hose

SERIES AH5

[Download publication 10.89](#) for complete information

- Flexible stainless steel hose, for use in suspended ceilings
- Up to 10× faster than threaded black pipe, eliminate messy cutting tools
- Minimum bend radius: cULus – 4" | 102 mm
- Sizes 24 – 72" | 610 – 1830 mm
- Pressures up to 175 psi | 1207 kPa | 12 bar

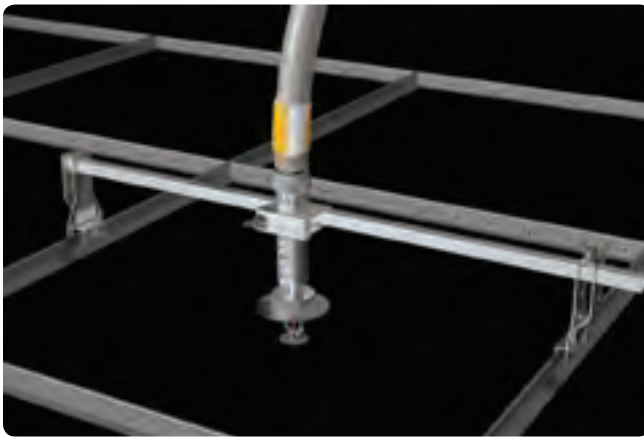

Certifications/Listings:



VicFlex™ Bracket with Center-Of-Tile and Tile-Install Features

STYLE AB1

[Download publications 10.84](#), [10.85](#), and [10.95](#) for complete information

- One-piece bracket, for suspended or hard-lid ceilings
- Allows installation before ceiling tile, eliminate messy cutting tools
- Sizes 24" | 610 mm and 48" | 1219 mm

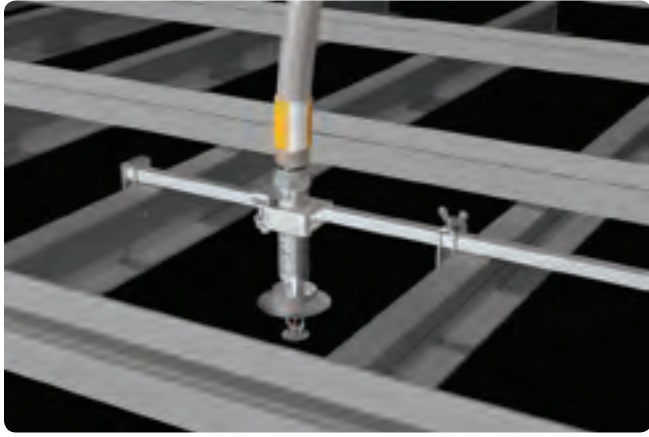

Certifications/Listings:



VicFlex™ Bracket with Adjustable-From-Below Center Bracket

STYLE AB2

[Download publications 10.84, 10.85, and 10.95](#) for complete information

- In-room elevation center bracket allows vertical adjustment without breaking the ceiling plane
- One-piece bracket, for suspended or hard-lid ceilings
- Allows installation before ceiling tile, eliminate messy cutting tools
- Sizes 24" | 610 mm and 48" | 1219 mm



Certifications/Listings:



VicFlex™ Bracket for Hat Channel with Adjustable-From-Below Center Bracket

STYLE AB4

[Download publications 10.84, 10.85, and 10.95](#) for complete information

- One-piece bracket, for hard-lid ceilings with hat furring channel grid system
- Up to 10x faster than threaded black pipe, eliminate messy cutting tools
- In-room elevation center bracket allows vertical adjustment without breaking the ceiling plane
- Sizes 24" | 610 mm and 48" | 1219 mm

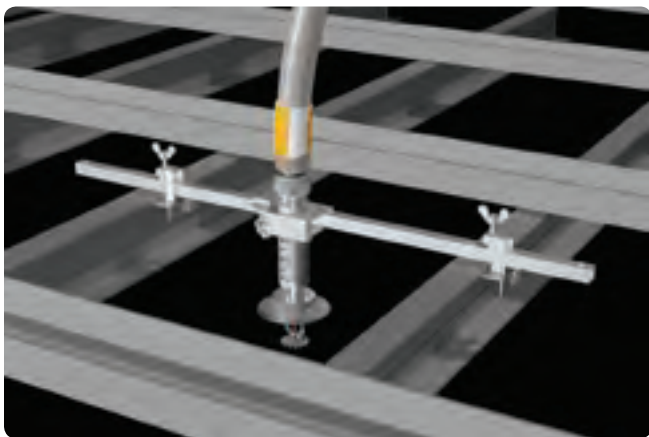

Certifications/Listings:



VicFlex™ Bracket Optimized for Wood and Metal Studs

STYLE AB5

[Download publications 10.85 and 10.95](#) for complete information

- No screws for metal studs; one-screw per side for wood studs
- In-room elevation center bracket allows vertical adjustment without breaking the ceiling plane
- Sizes 24" | 610 mm and 48" | 1219 mm

VicFlex™ Sprinkler Fitting System

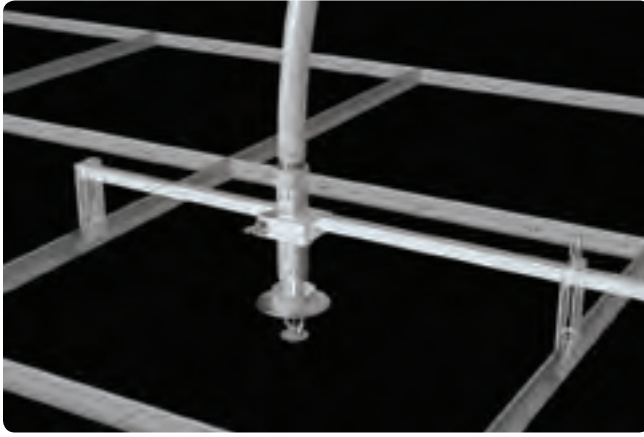

VicFlex™ Bracket

STYLE AB7

[Download publications 10.84, 10.85, 10.89, and 10.95](#) for complete information

- One-piece bracket, for suspended or hard-lid ceilings
- Up to 10× faster than threaded black pipe, eliminate messy cutting tools
- Sizes 24" | 610 mm and 48" | 1219 mm

Certifications/Listings:



VicFlex™ Bracket

STYLE AB7 ADJUSTABLE

[Download publications 10.84, 10.85, 10.89, and 10.95](#) for complete information

- One-piece bracket, for suspended or hard-lid ceilings
- Up to 10× faster than threaded black pipe, eliminate messy cutting tools
- Sizes 27½" | 700 mm and 55" | 1400 mm

Certifications/Listings:

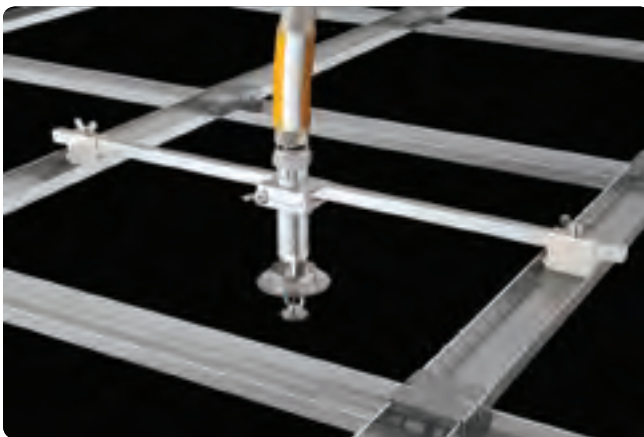

VicFlex™ Bracket for CD Profile

STYLE AB8

[Download publications 10.85 and 10.95](#) for complete information

- One-piece bracket, for hard-lid ceilings
- Up to 10× faster than threaded black pipe, eliminate messy cutting tools
- Sizes 24" | 610 mm and 48" | 1219 mm

Certifications/Listings:



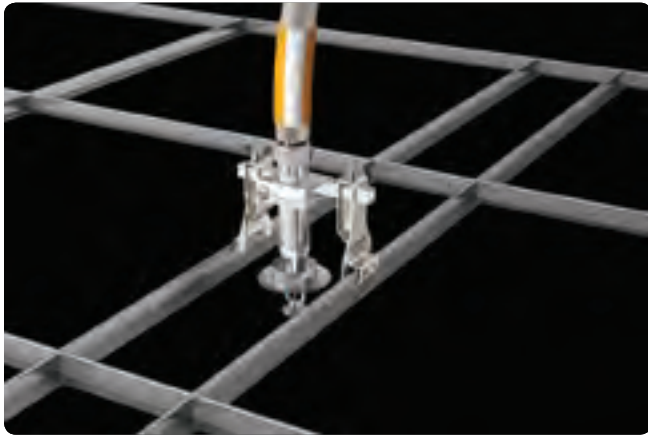

VicFlex™ Bracket for Armstrong® TechZone™

STYLE AB10

[Download publications 10.84, 10.85, and 10.95](#) for complete information

- One-piece bracket, for Armstrong™ TechZone™ ceilings
- Eliminate messy cutting tools
- Sizes 6" | 150 mm

Certifications/Listings:

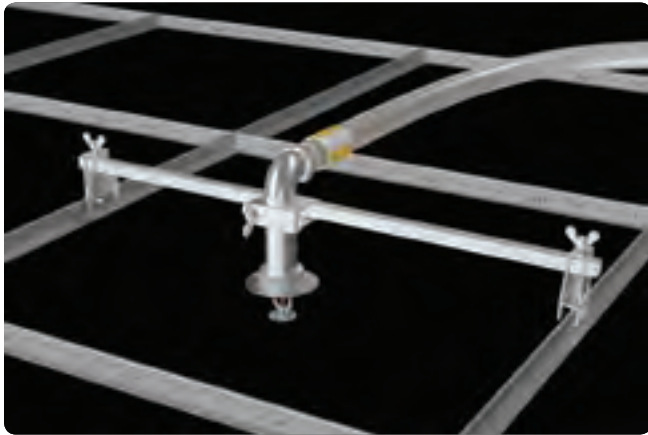

VicFlex™ Bracket for Low Profile Installations

STYLE AB11

[Download publications 10.85 and 10.95](#) for complete information

- Installs in spaces with clearances down to 6" | 150 mm total takeout
- For use only with 90° low profile elbows
- Sizes 24" | 610 mm and 48" | 1219 mm

Certifications/Listings:



VicFlex™ Bracket for Use with Threaded Rod

STYLE AB12

[Download publications 10.85 and 10.95](#) for complete information

- Designed to work from 36" | 914 mm down to 4" | 100 mm clearance from face of ceiling
- Allows installation before ceiling tile, eliminate messy cutting tools
- Standardized opening accepts 3/8" M10 standard threaded rod

Certifications/Listings:



VicFlex™ Sprinkler Fitting System

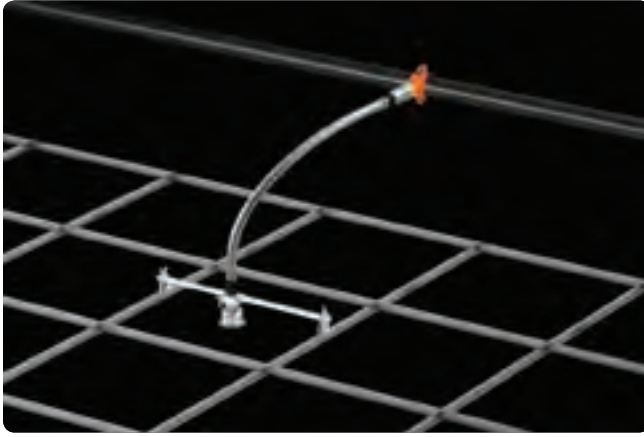

Certifications/Listings:



VicFlex™ Dry Sprinkler

STYLE VS1

[Download publication 10.91](#) for complete information

- Patented flexible dry sprinkler technology
- K5.6 Commercial Quick Response and Standard Response
- Pendent, concealed pendent, horizontal sidewall
- For use with *VicFlex* brackets: VB1 (wood and metal stud or joist), VB2 (recessed pendent, suspended ceilings), VB3 (concealed pendent, suspended ceilings)
- Minimum bend radius: 2" | 51 mm
- Sizes 38" | 965 mm, 50" | 1270 mm, 58" | 1475 mm



Certifications/Listings:



VicFlex™ for Surface Mount

STYLE AB3

[Download publications 10.85](#) and [10.95](#) for complete information

- One-piece bracket, for surface mount applications
- Up to 10× faster than threaded black pipe, eliminate messy cutting tools
- Reducer nipples sizes 5.75" | 140 mm, 9.0" | 230 mm, and 13" | 330 mm



Certifications/Listings:



VicFlex™ for Cold Storage

STYLE AB6

[Download publication 10.90](#) for complete information

- Assembly components: V36 dry sprinkler, Series AH2 braided hose, bracket assembly
- Cold storage applications, eliminates condensation and combats differential movement
- Up to 4× faster than threaded black pipe, eliminate messy cutting tools and foam seals
- Sizes 31–72" | 790–1830 mm



VicFlex™ for Duct

SERIES AQD

[Download publication 10.87](#) for complete information

- Fiberglass-reinforced plastic duct applications
- Square or round base mounts
- Minimum bend radius: FM – 6" | 150 mm
- Sizes 24–72" | 610–1830 mm
- Pressures up to 175 psi | 1207 kPa | 12 bar

Certifications/Listings:



VicFlex™ for Clean Rooms

SERIES AQC-U

[Download publication 10.86](#) for complete information

- Clean room applications
- Minimum bend radius: FM – 6" | 150 mm
- Sizes 24–72" | 610–1830 mm
- Pressures up to 175 psi | 1207 kPa | 12 bar

Certifications/Listings:



VicFlex™ Reducer Nipples and Elbows



















[Download publications 10.84, 10.85, 10.88](#) and [10.89](#) for complete information

- Reducer nipples sizes 5.75" | 140 mm, 9.0" | 230 mm, and 13" | 330 mm
- Reducer 90° elbows sizes 4.8" | 123 mm and 6.3" | 161 mm
- Reducer 90° low profile sizes 4.8" | 123 mm and 6.3" | 161 mm (for use with Style AB5, AB11 or AB12 brackets only)





Couplings

Victaulic®, the originator and innovator of grooved pipe joining technology, offers a wide variety of coupling styles and sizes for fire protection systems. In 1952, Victaulic developed the first UL Listed coupling and continues to build upon this legacy, providing products that facilitate fast and consistent installation. One key product development was the FireLock EZ™ Installation-Ready™ technology, eliminating the need to disassemble and reassemble components during installation.



Couplings	page	Couplings	page
 FireLock EZ Rigid Coupling (Style 009N)	11	 Plain End Installation-Ready™ Refuse-to-Fuse Coupling for HDPE Pipe (Style 905)	15
 FireLock™ Rigid Coupling (Style 005H)	11	 Refuse-to-Fuse Coupling for HDPE-to-Steel Pipe (Style 907)	15
 QuickVic™ Rigid Coupling (Style 107N)	11		
 Zero-Flex™ Rigid Coupling (Style 07)	12		
 QuickVic Flexible Coupling (Style 177N)	12	Adapters	page
 Standard Flexible Coupling (Style 77)	12	 FireLock Flange Adapter (Style 744)	16
 Flexible Coupling (Style 75)	13	 Vic-Flange Adapter (Style 741)	16
 Reducing Coupling (Style 750)	13	 Vic-Flange Adapter (Style 743)	16
 AGS Flexible Coupling (Style W77)	13		
 Rigid Coupling for Type 316 Stainless Steel (Style 489)	14		
 Outlet Coupling (Style 72)	14		
 High Pressure Rigid Coupling (Style HP-70)	14		
 Vic-Boltless Coupling and Tool (Styles 791 and 792)	15		
 FireLock IGS Installation-Ready™ Rigid Coupling (Style 108)	22		

Couplings

Gasket Type	Style 009N	Style 005	Style 07	Style 107N	Style 77	Style 177N	Style 75	Style 750	Style W77	Style 489	Style 72 †	Style HP-70	Style 791
Standard 		•	•		•		•				•	•	•
Reducing 								•					
Flush-Seal™ 		•	•		•		•		•				•
Installation-Ready™ 	•			•		•							

† Separate gasket specifically designed for outlet couplings.

FireLock EZ™ Style 009N

Installation-Ready means fast, dependable no-nonsense productivity

Improved:

- 50% Reduced installation effort
- 100% Improved battery life

Continued:

- Fast, consistent installation
- Easy visual confirmation

As easy as it gets:

- No loose parts to drop or cause injury
- Ships ready to install
- 1¼–12" | DN32–DN300
- Pressures up to 365 psi | 2517 kPa | 25 bar



Couplings

INSTALLATION-
READY™

FireLock EZ™ Rigid Coupling

STYLE 009N

[Download publication 10.64](#) for complete information

- Angled bolt pad provides rigidity
- Sizes 1¼ – 12" | DN32 – DN300
- Pressures up to 365 psi | 2517 kPa | 25 bar

Certifications/Listings:



FireLock™ Rigid Coupling

STYLE 005H

[Download publication 10.02](#) for complete information

- Angled bolt pad provides rigidity
- Sizes 1¼ – 8" | DN32 – DN200
- Pressures up to 350 psi | 2413 kPa | 24 bar

Certifications/Listings:

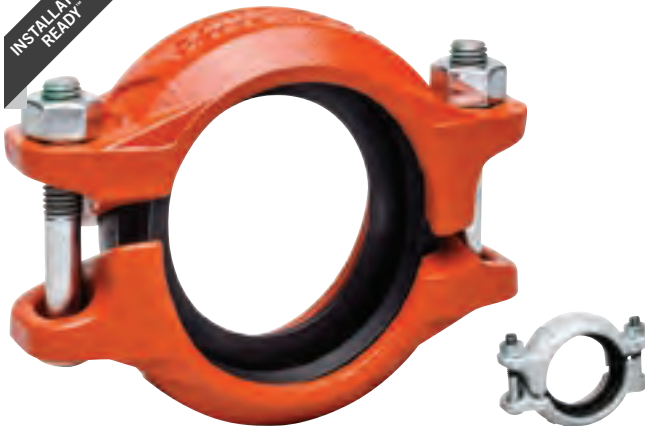
INSTALLATION-
READY™

QuickVic™ Rigid Coupling

STYLE 107N

[Download publication 06.23](#) for complete information

- Angled bolt pad provides rigidity
- Sizes from 2 – 12" | DN50 – DN300
- Pressures up to 750 psi | 5171 kPa | 52 bar

Certifications/Listings:





Zero-Flex™ Rigid Coupling

STYLE 07

[Download publication 06.02](#) for complete information

- Angled bolt pad provides rigidity
- Sizes from 1–12" | DN25–DN300
- Pressures up to 750 psi | 5171 kPa | 52 bar
- For sizes 14–50" | DN350–DN1250, [download publication 20.02](#) for information on AGS Style W07

Certifications/Listings:



QuickVic™ Flexible Coupling

STYLE 177N

[Download publication 06.24](#) for complete information

- Sizes from 2–8" | DN50–DN200
- Pressures up to 1000 psi | 6895 kPa | 69 bar

Certifications/Listings:



Flexible Coupling

STYLE 77

[Download publication 06.04](#) for complete information

- Cross-ribbed, two piece housing construction
- Sizes from ¾–24" | DN20–DN600
- Pressures up to 1000 psi | 6895 kPa | 69 bar
- For sizes 14–72" | DN350–DN1800, [download publication 20.03](#) for information on AGS Style W77

Certifications/Listings:



Couplings



Flexible Coupling

STYLE 75

[Download publication 06.05](#) for complete information

- Lightweight coupling for moderate pressures
- Sizes from 1–8" | DN25–DN200
- Pressures up to 500 psi | 3447 kPa | 34 bar

Certifications/Listings:



Reducing Coupling

STYLE 750

[Download publication 06.08](#) for complete information

- Replaces two couplings and a reducing fitting
- Sizes from 2–10" | DN50–DN250
- Pressures up to 500 psi | 3447 kPa | 34 bar

Certifications/Listings:



AGS Flexible Coupling

STYLE W77

[Download publication 20.03](#) for complete information

- Unique wedge shaped key profile increases allowable pipe end separation
- Sizes from 14–72" | DN350–DN1800
- Pressures up to 350 psi | 2413 kPa | 24 bar
- For original groove sizes ¾–24" | DN20–DN600 (Style 77), [download publication 06.04](#);
For original groove couplings featuring *Installation-Ready* technology sizes 2–8" | DN50–DN200 (Style 177N), [download publication 06.24](#)

Certifications/Listings:





Rigid Coupling for Type 316 Stainless Steel

STYLE 489

[Download publication 17.25](#) for complete information

- Greatly reduces linear or angular movement and is useful for valve connections where rigidity is required
- Sizes from 1½–12" | DN40–DN300
- Pressures up to 600 psi | 4137 kPa | 41 bar
- For the duplex stainless steel coupling, [download publication 17.33](#) for Style 489DX

Certifications/Listings:



Outlet Coupling

STYLE 72

[Download publication 06.10](#) for complete information

- Joining device to provide an integral reducing outlet
- Sizes from 1½–6" | DN40–DN150
- Pressures up to 500 psi | 3447 kPa | 34 bar

Certifications/Listings:



High Pressure Rigid Coupling

STYLE HP-70

[Download publication 06.12](#) for complete information

- Heavy housing for high pressure service
- Sizes from 2–16" | DN50–DN400
- Pressures up to 1000 psi | 6895 kPa | 69 bar

Certifications/Listings:



Couplings



Certifications/Listings:

**Vic-Boltless Coupling and Tool**

STYLE 791 COUPLING AND 792 TOOL

[Download publication 06.11](#) for complete information

- Provides a secure, tamper resistant, low profile joint
- Installed only with Victaulic® Style 792 tool
- Sizes from 2–8" | DN50–DN200
- Pressures up to 700 psi | 4826 kPa | 48 bar

A diagonal banner with the text "INSTALLATION-READY™" in white on a black background.



Certifications/Listings:

**Plain End Installation-Ready™ Refuse-to-Fuse™ Coupling for HDPE Pipe**

STYLE 905

[Download publication 19.07](#) for complete information

- Designed for plain end HDPE pipe from DR7–DR17
- Sizes from 2–8" IPS and 63–225mm ISO
- Pressure rating meets or exceeds the performance capabilities of the pipe

A diagonal banner with the text "INSTALLATION-READY™" in white on a black background.



Certifications/Listings:

**Refuse-to-Fuse™ Coupling for HDPE-to-Steel Pipe**

STYLE 907

[Download publication 19.10](#) for complete information

- Designed to provide a single transition from plain end HDPE pipe from DR7–DR17 to grooved steel sized piping system components
- Sizes from 2–8" IPS HDPE to 2–8" IPS grooved steel
- Sizes from 63–225 mm ISO HDPE to 2–8" ISO grooved steel
- Pressure rating meets or exceeds the performance capability of the pipe



FireLock™ Flange Adapter

STYLE 744

[Download publication 10.04](#) for complete information

- ANSI Class 125 and 150 flanges
- Sizes 2–8" | DN50–DN200
- Pressures up to 175 psi | 1207 kPa | 12 bar
- Regional availability, contact [Victaulic](#) for details

Certifications/Listings:



Vic-Flange Adapter

STYLE 741

[Download publication 06.06](#) for complete information

- ANSI Class 125 and 150, Australian Standard Table E, PN10/16, and JIS 10K
- Sizes from 2–24" | DN50–DN600
- Pressures up to 300 psi | 2068 kPa | 21 bar
- For AGS sizes 14–24" | DN350–DN600, [download publication 20.04](#) for information on AGS Style W741

Certifications/Listings:



Vic-Flange Adapter

STYLE 743

[Download publication 06.06](#) for complete information

- ANSI Class 300 flanges
- Sizes from 2–12" | DN50–DN300
- Pressures up to 720 psi | 4964 kPa | 50 bar

Certifications/Listings:







Fittings





Committed to innovation, Victaulic® FireLock™ Installation-Ready™ fittings and FireLock IGS for small diameter (1-inch) applications continue the tradition of enhancing ease and speed of installation. Rendering threaded connections obsolete, Victaulic mechanical joining solutions ensure complete system confidence and increase jobsite safety.









FireLock Installation-Ready™ Fittings

	90° Elbow (No. 101)	18
	45° Elbow (No. 103)	18
	Straight Tee (No. 102)	18
	Close Nipple (No. 143)	18

Standard Grooved End Fittings

	90° Elbow (No. 10)	19
	45° Elbow (No. 11)	19
	Straight Tee (No. 20)	19
	Cap (No. 60)	19

FireLock Fittings

	90° Elbow (No. 001)	18
	45° Elbow (No. 003)	18
	Straight Tee (No. 002)	18
	Cap (No. 006)	18
	Drain Elbow (No. 10-DR)	18
	Vic-End II End of Run Elbow (No. 67)	19



Innovative Groove System (IGS) products feature a new, patented IGS groove specification, optimized for 1-inch pipe, and are cULus Listed and FM Approved for service up to 365 psi | 2517 kPa | 25 bar.

See pg. 21 for more information.

INSTALLATION-READY™



FireLock™ Installation-Ready™ Fittings

NO. 101 90° ELBOW, NO. 103 45° ELBOW,
NO. 102 STRAIGHT TEE, NO. 143 CLOSE NIPPLE

[Download publication 10.06](#) for complete information

- Convenience of a one-piece fitting with the dependability of the FireLock EZ™ Style 009N rigid coupling
- Up to 4 times faster to install than traditional couplings and fittings
- Up to 10 times faster to install than threading
- Fittings available from 1¼–2½" | DN32 – 73.0 mm, and DN65
- Regional availability, contact [Victaulic](#) for details

Certifications/Listings:



FireLock™ Fittings

NO. 001 90° ELBOW
NO. 003 45° ELBOW
NO. 002 STRAIGHT TEE
NO. 006 CAP

[Download publication 10.03](#) for complete information

- *FireLock* full-flow elbows and tees feature CAD-developed, hydrodynamic design, affording a shorter center-to-end dimension than standard fittings
- Noticeable bulge allows the water to make a smoother turn to maintain similar flow characteristics as standard full flow fittings
- Fittings available from 1¼–8" | DN32–DN200

Certifications/Listings:



Drain Elbow

NO. 10-DR

[Download publication 10.05](#) for complete information

- Standard fitting pressure ratings conform to ratings of installed coupling
- All fittings supplied with grooves for fast installation
- Fittings available from 2½–6" | 73.0 mm–DN150

Certifications/Listings:



Fittings



Vic™-End II End of Run Elbow

NO. 67

[Download publication 10.21](#) for complete information

- Standard fitting pressure ratings conform to ratings of installed coupling
- All fittings supplied with grooves for fast installation
- Fittings available from 1¼–3" | DN32–DN80

Certifications/Listings:



Standard Grooved End Fittings

NO. 10 90° ELBOW

NO. 11 45° ELBOW

NO. 20 STRAIGHT TEE

NO. 60 CAP

[Download publication 07.01](#) for complete information on original grooved end fittings for carbon steel pipe

- Standard fitting pressure ratings conform to ratings of installed coupling
- All fittings supplied with grooves for fast installation
- Fittings available from ¾–12" | DN20–DN600

Certifications/Listings:



Intro

VicFlex™

Couplings

Fittings

FireLock™ GS

Hole Cut

Valves and
Accessories

Devices and
Accessories

Hydraulic
Control Valves

Automatic
Sprinklers

Victaulic™
Vortex™

Specialty
Systems

Pipe Preparation
Tools

Design Data

Index

Innovative Groove System *IGS*

Innovative Groove System (IGS) products feature a new, patented IGS groove specification, optimized for 1-inch pipe, and are cULus Listed and FM Approved for service up to 365 psi | 2517 kPa | 25 bar. Eliminating the use of pipe wrenches, which can cause injury from repeated strenuous motion, the combination of products allows customers to prep and install hard pipe faster and cleaner. The roll groove maintains pipe thickness, therefore improving corrosion resistance and provides a visual confirmation of pad-to-pad installation.

- Regional availability, contact [Victaulic](#) for details





FireLock IGS Installation-Ready™ Fittings

 90° Elbow (No. 101)	22
 Straight Tee (No. 102)	22







FireLock IGS Installation-Ready™ Coupling

 Rigid Coupling (Style 108)	22
--	----

FireLock IGS Outlets

 Outlet-T (Style 922)	23
 Welded Outlet (No. 142)	23

FireLock IGS Fittings and Adapters

 Close Nipple (No. 143)	24
 Sprinkler Reducer (No. 148)	24
 Female Threaded × Groove 90° Elbow (No. 145)	24
 Male Threaded × Groove Adapter (No. 140)	24
 Female Threaded × Groove Adapter (No. 141)	24
 Cap (No. 146)	24

Pipe Preparation Tools

 RG2100 Roll Grooving Tool	78
---	----

INSTALLATION-
READY™



FireLock™ IGS Installation-Ready™ Fittings

NO. 101 90° ELBOW
NO. 102 STRAIGHT TEE

[Download publication 10.54](#) for complete information

- Convenience of a one-piece fitting with the dependability of the FireLock EZ™ Style 009N rigid coupling
- Utilizes the proprietary IGS groove specification, [download publication 25.14](#)
- Optimized for 1" | DN25 pipe
- Pressures up to 365 psi | 2517 kPa | 25 bar

Certifications/Listings:



INSTALLATION-
READY™



FireLock™ IGS Installation-Ready™ Rigid Coupling

STYLE 108

[Download publication 10.54](#) for complete information

- Patent pending one-bolt coupling
- Utilizes the proprietary IGS groove specification, [download publication 25.14](#)
- Optimized for 1" | DN25 pipe
- Pressures up to 365 psi | 2517 kPa | 25 bar

Certifications/Listings:





FireLock™ IGS Outlet-T

STYLE 922

[Download publication 10.54](#) for complete information

- Provides a direct branch connection at any location where a hole can be cut in the pipe
- Utilizes the proprietary IGS groove specification, [download publication 25.14](#)
- Available from 1¼–2½" | DN32–73.0 mm with 1" | DN25 outlet

Certifications/Listings:



FireLock™ IGS Welded Outlet

NO. 142

[Download publication 10.54](#) for complete information

- Provides a direct branch connection at any location where a hole can be cut in the pipe and outlet can be welded on
- Utilizes the proprietary IGS groove specification, [download publication 25.14](#)
- Available from 1¼–4" | DN32–DN100 saddle with 1" | DN25 outlet

Certifications/Listings:

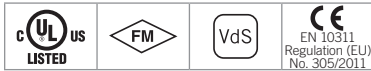



FireLock™ IGS Fittings and Adapters

- NO. 143 CLOSE NIPPLE
- NO. 148 SPRINKLER REDUCER
- NO. 145 FEMALE THREADED × GROOVE 90° ELBOW
- NO. 140 MALE THREADED × GROOVE ADAPTER
- NO. 141 FEMALE THREADED × GROOVE ADAPTER
- NO. 146 CAP

[Download publication 10.54](#) for complete information

- Utilizes the proprietary IGS groove specification, [download publication 25.14](#)
- Optimized for 1" | DN25 pipe
- Fitting pressure ratings conform to rating of installed coupling

Certifications/Listings:



FireLock™ IGS Roll Grooving Tool

RG2100

[Download publication 10.54](#) for complete information

- Features a cast carriage for use on a standard Ridgid™ 300 Power Drive
- Carriage accepts:
 - RG2100 tool head
 - Cutter
 - Reamer
 - Lever
- Grooves to the proprietary IGS groove specification, [download publication 25.14](#)
- Optimized to roll groove IGS 1" | DN25 carbon steel Schedule 40 down to Schedule 10 pipe

Hole Cut Systems

Victaulic® developed the hole cut piping system concept to enable a fast and easy mid-pipe outlet solution that would not require welding. The system allows for a direct branch connection at any location where a hole can be cut in the pipe. Gaskets are molded to conform to the outer diameter of the pipe and are pressure responsive to provide a seal.



Outlets

page

Tools

page



FireLock™ Outlet-T (Style 922)

25



Hole Cutting Tools

81–82



FireLock IGS Outlet-T (Style 922)

23



FireLock Low-Profile Sprinkler Tee – EMEA only (Style 912)

26



Mechanical-T Outlet (Style 920/920N)

26



Strapless Outlet (Style 923)

26



FireLock IGS Welded Outlet (No. 142)

23



FireLock™ Outlet-T

STYLE 922

[Download publication 10.52](#) for complete information

- Provides a direct branch connection at any location where a hole can be cut in the pipe
- Available as female threaded outlet
- Sizes from 1¼–2½" | DN32–73.0 mm, and DN65
- Pressures up to 300 psi | 2068 kPa | 21 bar
- Also available with a FireLock IGS 1" | DN25 grooved outlet, see pg. 23

Certifications/Listings:





FireLock™ Low Profile Sprinkler Tee – EMEA only

STYLE 912

[Download publication 10.53](#) for complete information

- Provides a direct branch connection for sprinklers only at any location where a hole can be cut in the pipe
- Sizes from 1 – 1½" | DN25 – DN40
- Pressures up to 300 psi | 2068 kPa | 21 bar

Certifications/Listings:



Mechanical-T Bolted Branch Outlet and Cross Assemblies

STYLE 920/920N

[Download publication 11.02](#) for complete information

- Provides a direct branch connection at any location where a hole can be cut in the pipe
- Available as a tee or cross outlet with female threaded or grooved ends
- Sizes from 2 – 8" | DN50 – DN200
- Pressures up to 500 psi | 3447 kPa | 34 bar

Certifications/Listings:



Vic-Let Strapless Outlet

STYLE 923

[Download publication 11.05](#) for complete information

- Provides a fast, easy pipe outlet without the need for a strap or lower housing
- Sizes from 4 – 10" | DN100 – DN250
- Pressures up to 300 psi | 2068 kPa | 21 bar

Certifications/Listings:



Valves and Accessories

Since 1919, Victaulic® has been committed to innovation in the pursuit of faster and easier ways to join piping systems. Specifically within the Fire Protection industry, Victaulic continues to simplify the installation process by reducing individual pieces and parts by engineering unique products that serve multiple functions and have smaller footprints. Evidence of this practice can be seen in the FireLock™ Commercial Zone Control Riser Module (Series 747M) and the Alarm Test Module.



Valves	page	Valves	page
<i>FireLock</i> Butterfly Valve – Supervised Open (Series 705)	28	<i>FireLock</i> Ball Valve (Series 728)	31
<i>FireLock</i> High Pressure Butterfly Valve – Supervised Open (Series 765)	28	<i>FireLock</i> Ball Valve (Series 722)	31
<i>FireLock</i> Butterfly Valve – Supervised Closed (Series 707C)	28	<i>FireLock</i> Residential Zone Control Riser Module (Series 247)	32
<i>FireLock</i> High Pressure Butterfly Valve – Supervised Closed (Series 766)	29	<i>FireLock</i> Commercial Zone Control Riser Module (Series 747M)	32
<i>FireLock</i> Check Valve (Series 717)	29		
<i>FireLock</i> High Pressure Check Valve (Series 717H)	29	Accessories	page
<i>FireLock</i> Riser Check Valve (Series 717R)	30	<i>FireLock</i> Wall Post Indicator (Series 773)	33
<i>FireLock</i> Riser Check Valve (Series 717HR)	30	<i>FireLock</i> Upright Post Indicator (Series 774)	33
<i>FireLock</i> OS&Y Gate Valves (Series 771H/771F)	30	TestMaster™ II Alarm Test Module (Series 720)	33
<i>FireLock</i> NRS Gate Valves (Series 772H/772F)	31	Fire Pump Test Meter (Series 735)	34
		<i>FireLock</i> Wye Type Vic-Strainer (Series 732H)	34



FireLock™ Butterfly Valve – Supervised Open

SERIES 705

[Download publication 10.81](#) for complete information

- Weatherproof actuator housing approved for indoor or outdoor use
- Ductile iron body and disc with EPDM seats
- Sizes from 2–12" | DN50–DN300
- Pressures up to 300 psi | 2068 kPa | 21 bar

Certifications/Listings:



FireLock™ High Pressure Butterfly Valve – Supervised Open

SERIES 765

[Download publication 10.80](#) for complete information

- Weatherproof actuator housing approved for indoor or outdoor use
- Ductile iron body and disc with nitrile seats
- Sizes from 2–12" | DN50–DN300
- Pressures up to 365 psi | 2517 kPa | 25 bar

Certifications/Listings:



FireLock™ Butterfly Valve – Supervised Closed

SERIES 707C

[Download publication 10.75](#) for complete information

- Design to be Supervised Closed during normal operating conditions
- Ductile iron body and disc with EPDM seats
- Sizes from 2–8" | DN50–DN200
- Pressures up to 300 psi | 2068 kPa | 21 bar

Certifications/Listings:



Valves and Accessories



Certifications/Listings:



FireLock™ High Pressure Butterfly Valve – Supervised Closed

SERIES 766

[Download publication 10.83](#) for complete information

- Designed to be Supervised Closed during normal operating conditions
- Ductile iron body and disc with nitrile seats
- Sizes from 2–12" | DN50–DN300
- Pressures up to 365 psi | 2517 kPa | 25 bar



Certifications/Listings:



FireLock™ Check Valve

SERIES 717

[Download publication 10.08](#) for complete information

- Features an elastomer encapsulated disc with an electroless nickel plated seat
- Sizes from 2½–12" | 73.0 mm–DN300
- Pressures up to 365 psi | 2517 kPa | 25 bar



Certifications/Listings:



FireLock™ High Pressure Check Valve

SERIES 717H

[Download publication 10.08](#) for complete information

- Features a stainless steel disc which seats against the O-ring seal, when mounted on the electroless nickel plated face
- Sizes from 2–3" | DN50–DN80 mm
- Pressures up to 365 psi | 2517 kPa | 25 bar



FireLock™ Riser Check Valve

SERIES 717R

[Download publication 10.09](#) for complete information

- Features an elastomer encapsulated disc with an electroless nickel plated seat
- Includes upstream and downstream pressure taps, must specify riser check kit when ordered
- Sizes from 4–8" | DN100–DN200
- Pressures up to 365 psi | 2517 kPa | 25 bar

Certifications/Listings:



FireLock™ High Pressure Riser Check Valve

SERIES 717HR

[Download publication 10.09](#) for complete information

- Features a stainless steel disc which seats against the O-ring seal, when mounted on the electroless nickel plated face
- Includes upstream and downstream pressure taps, must specify riser check kit when ordered
- Sizes from 2–3" | DN50–DN80
- Pressures up to 365 psi | 2517 kPa | 25 bar

Certifications/Listings:



FireLock™ OS&Y Gate Valves

SERIES 771H and 771F

[Download publication 10.92](#) for complete information

- Available as Groove × Groove or Groove × Flange*
- Used when positive shut-off is required in a fire line and a quick visual indicator of open/closed position is needed
- Sizes from 2½–12" | 73.0 mm–DN300
- Pressures up to 250 psi | 1724 kPa | 17 bar

* Flange only available in ANSI

Certifications/Listings:



Valves and Accessories



Certifications/Listings:



FireLock™ NRS Gate Valves

SERIES 772H and 772F

[Download publication 10.92](#) for complete information

- Available as Groove × Groove or Groove × Flange*
 - Used for shut-off service where the valve is operated remotely
 - Sizes from 2½–12" | 73.0 mm–DN300
 - Pressures up to 250 psi | 1724 kPa | 17 bar
- * Flange only available in ANSI



Certifications/Listings:



FireLock™ Ball Valve

SERIES 728

[Download publication 10.17](#) for complete information

- Standard port and supervisory switch, available with grooved or female threaded ends
- Sizes from 1–2" | DN25–DN50
- Pressures up to 365 psi | 2517 kPa | 25 bar



Certifications/Listings:



Brass Body Ball Valve — Threaded

SERIES 722

[Download publication 08.15](#) for complete information

- Standard port, female threaded end valve constructed from forged brass
- Sizes from ¼–2" | DN8–DN50
- Pressures up to 600 psi | 4137 kPa | 41 bar



Certifications/Listings:



FireLock™ Residential Zone Control Riser Module

SERIES 247

[Download publication 10.97](#) for complete information

- Features a cast body with shut off valve, test and drain valve combination and different sizes, flow switch, and a pressure gauge
- Sizes from 1–2" | DN25–DN50
- Pressures up to 365 psi | 2517 kPa | 25 bar



Certifications/Listings:



FireLock™ Commercial Zone Control Riser Module

SERIES 747M

[Download publication 10.96](#) for complete information

- Features a cast body with shut off valve, test and drain valve combination and different sizes, flow switch, and a pressure gauge
- Sizes from 1¼–6" | DN32–DN150
- Pressures up to 365 psi | 2517 kPa | 25 bar

Valves and Accessories



FireLock™ Wall Post Indicator

SERIES 773

[Download publication 10.92](#) for complete information

- For use with *FireLock* NRS gate valves, see pg. 31
- Sizes from 2½–12" | 73.0 mm–DN300

Certifications/Listings:



FireLock™ Upright Post Indicator

SERIES 774

[Download publication 10.92](#) for complete information

- For use with *FireLock* NRS gate valves, see pg. 31
- Sizes from 2½–12" | 73.0 mm–DN300

Certifications/Listings:



TestMaster™ II Alarm Test Module

SERIES 720

[Download publication 10.22](#) for complete information

- Available with grooved or female threaded ends, and pressure relief valve
- Sizes from 1–2" | DN25–DN50
- Pressures up to 300 psi | 2068 kPa | 21 bar

Certifications/Listings:



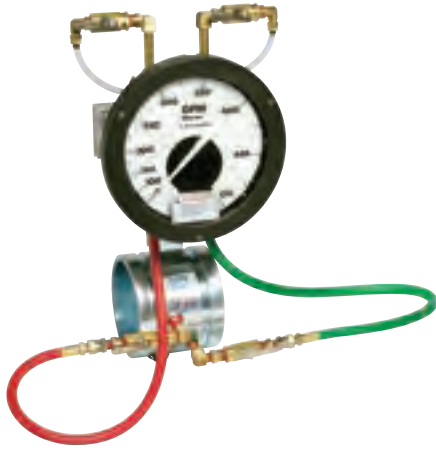

Fire Pump Test Meter

SERIES 735

[Download publication 10.11](#) for complete information

- Sizes from 2½ – 12" | 73.0 mm – DN300
- Model "L" pressure rated up to 175 psi | 1207 kPa | 12 bar
- Model "S" pressure rated up to 500 psi | 3447 kPa | 34 bar

Certifications/Listings:



FireLock™ Wye Type Vic-Strainer

SERIES 732H

[Download publication 10.68](#) for complete information

- Provides straight through flow for lower pressure drop
- Sizes from 2 – 4" | DN50 – DN100
- Pressures up to 365 psi | 2517 kPa | 25 bar





















Certifications/Listings:



Devices and Accessories

FireLock NXT™ devices offer another leap forward in valve design and operation. Featuring a lower operating pressure and ultra-fast trip time, due to the elimination of the air-to-water differential, *FireLock NXT* devices deliver greater operational dependability and are easier to install, service and maintain. In addition, the compact trim and diaphragm design reduces the valve's center-to-back take out distance up to a full 7" | 178 mm when compared with competitive valves.



Devices	page	Accessories	page
 <i>FireLock NXT</i> Dry System Check Valve (Series 768N)	37	 Air Maintenance/Compressor Assembly (Series 7C7)	41
 <i>FireLock NXT</i> Deluge System Check Valve (Series 769N)	37	 Electronic/Pneumatic Double Interlock Actuator (Series 767)	41
 <i>FireLock NXT</i> Preaction System Check Valve (Series 769N)	37	 Low Pressure Actuator (Series 776)	41
 <i>FireLock NXT</i> Preaction System with AutoConvert Assembly (Series 769N)	38	 Double Pneumatic Actuator (Series 798)	42
 <i>FireLock Fire-Pac</i> (Series 745)	38	 <i>FireLock</i> Ball Check Valve (Series 748)	42
 <i>FireLock NXT</i> Alternate Wet/Dry System Check Valve – Europe Only (Series 764)	39	 <i>FireLock</i> Auto Drain (Series 749)	42
 FireLock™ Alarm Check Valve (Series 751)	39	 Manual Release Panel (Series 755)	43
 <i>FireLock</i> European Alarm Check Valve Station (Series 751)	39	 <i>FireLock</i> Dry Accelerator (Series 746-LPA)	43
		 <i>FireLock</i> Retard Chamber (Series 752)	43
		 <i>FireLock</i> Air Maintenance Trim Assembly (Series 757 and 757P)	44
		 Water Column Drain Kit (Series 75D)	44
		 Supplemental Alarm Kit (Series 75B)	44
		 Water Motor Alarm (Series 760)	45

LEFT EQUALS AIR.
RIGHT EQUALS WATER.
NO CONFUSION.



AIR

Charge the system to 13 psi | 90 kPa | 0.9 bar minimum



BALL VALVE (WATER)

Open the charge line ball valve. Allow water to flow through the auto drain tube.



CONTROL VALVE

Slowly open the water supply main control valve until water flows from the open water supply main drain valve. Close the water supply main drain valve.

Note: Please reference the complete installation instructions before operating the valve.

STREAMLINED
SET-UP.
AS EASY AS





Valve shown with Vic-Quick riser.

Certifications/Listings:**FireLock NXT™ Check Device****SERIES 768N Dry System**

[Download publication 31.80](#) for complete information

- For use where piping may freeze such as unheated warehouses, outdoor parking garages or stadiums
- Actuation options: Series 776 low pressure actuator
- Available bare, pretrimmed, as a Vic™-Quick riser or in a Series 745 FireLock™ *Fire-Pac* cabinet
- Sizes from 1½–8" | DN40–DN200
- Pressures up to 300 psi | 2068 kPa | 20 bar



Valve shown with Vic-Quick riser.

Certifications/Listings:**FireLock NXT™ Check Device****SERIES 769N Deluge System**

[Download publication 31.81](#) for complete information

- For use where water curtains and fast water delivery are required such as highly-flammable material storage facilities or airplane hangars
- Actuation options: *FireLock* solenoid actuator, Series 776 low pressure actuator
- Available bare, pretrimmed, as a Vic-Quick riser or in a Series 745 *FireLock Fire-Pac* cabinet
- Sizes from 1½–8" | DN40–DN200
- Pressures up to 300 psi | 2068 kPa | 20 bar



Valve shown with Vic-Quick riser.

Certifications/Listings:**FireLock NXT™ Check Device****SERIES 769N Preaction System**

[Download publication 31.82](#) for complete information

- For use where redundant safeguards against system activation are required such as priceless art storage, libraries or data centers
- Actuation options: *FireLock* solenoid actuator, Series 776 low pressure actuator, Series 767 electric/pneumatic actuator, Series 798 double pneumatic actuator
- Available bare, pretrimmed, as a Vic-Quick riser or in a Series 745 *FireLock Fire-Pac* cabinet
- Sizes from 1½–8" | DN40–DN200
- Pressures up to 300 psi | 2068 kPa | 20 bar



AutoConvert Assembly

For SERIES 769N Electric Release

[Download publication 30.84](#) for complete information

- In the event of an AC power loss, the AutoConvert module latches from Closed to Open with a quick electrical pulse
- For use with Series 769N electric release valves sizes from 1½–8" | DN40–DN200
- Pressures up to 300 psi | 2068 kPa | 20 bar

Certifications/Listings:



FireLock™ Fire-Pac

SERIES 745

[Download publication 30.23](#) for complete information

- Completely preassembled fire protection valve enclosed in weatherproof cabinet
- Sizes from 1½–8" | DN40–DN200
- Pressures up to 300 psi | 2068 kPa | 20 bar

Certifications/Listings:



Customized Solutions

With more options available than ever before each Fire-Pac System is completely unique.

- Weatherproofing to NEMA 4 standards
- Pipe feed and drain can be located on the left, right or bottom panels
- Insulation and heating components available down to a minimum ambient temperature of 20°F | -6°C
- Compressor and nitrogen fill kit options
- Panel design options now including an addressable panel capable of networking with other intelligent devices
- Special cabinet color option

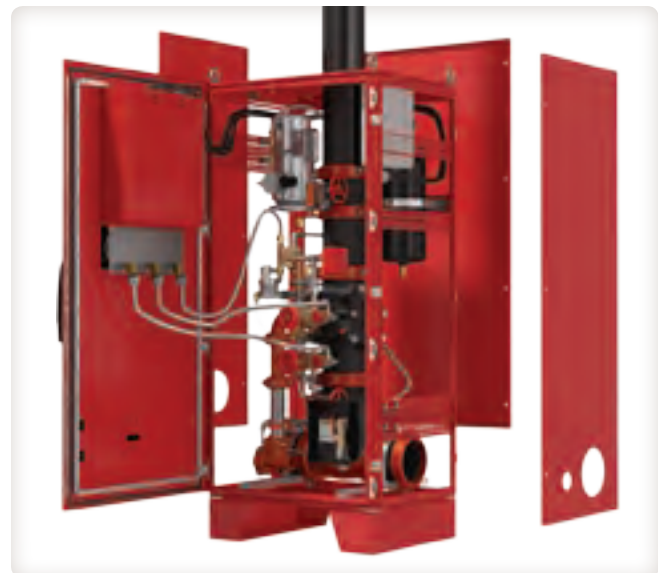

Devices and Accessories



Certifications/Listings:



FireLock NXT™ Alternate Wet/Dry System Check Valve – Europe Only

SERIES 764

[Download publication 30.83](#) for complete information

- Available bare, pretrimmed, or as a Vic™-Quick riser
- Sizes from 1½–8" | DN40–DN200
- Pressures up to 300 psi | 2068 kPa | 20 bar



Certifications/Listings:



FireLock™ Alarm Check Valve

SERIES 751

[Download publication 30.01](#) for complete information

- Prevents the reverse flow of water from the system piping to the water supply
- Sizes from 1½–8" | DN40–DN200
- Pressures up to 300 psi | 2068 kPa | 21 bar



Certifications/Listings:







FireLock™ European Alarm Check Valve Station

SERIES 751

[Download publication 30.01](#) for complete information

- Prevents the reverse flow of water from the system piping to the water supply
- Trim package includes alarm pressure switch and control valve
- Sizes from 1½–8" | DN40–DN200
- Pressures up to 300 psi | 2068 kPa | 21 bar

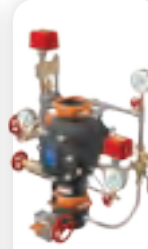
Accessories Compatibility Chart

					
	Series 768N Dry	Series 769N Deluge	Series 769N Preaction	Series 764 Alternate Wet/Dry	Series 751 Alarm Series 751 European Alarm Check Valve Station
STANDARD					
Series 7C7 Compressor Package	•	•	•	•	
Series 767 Electric/Pneumatic Actuator			•		
Series 776 Low Pressure Actuator	•	•	•	•	
Series 798 Double Pneumatic Actuator			•		
Series 729 Ball Drip Assembly	•	•	•	•	
Series 748 Ball Check Valve	•	•	•	•	
Series 749 Auto Drain Assembly	•	•	•	•	
Series 755 Manual Pull Station		•	•		
OPTIONAL					
Series 746 Dry Accelerator	•	•	•	•	
Series 746-LPA Dry Accelerator	•	•	•	•	
Series 752 FireLock™ Retard Chamber					•
Series 757/757P Air Maintenance Trim Assembly	•	•	•	•	
Series 75-D Water Column Component Drain Kit	•	•	•	•	
Series 75-B Supplemental Alarm Kit	•	•	•	•	
Series 760 Water Motor Alarm	•	•	•	•	•
Drain Connection Kit	•	•	•	•	•
AutoConvert Trim Assembly			•		
ELECTRICAL					
Alarm Pressure Switches	•	•	•	•	•
Supervisory Switches	•	•	•	•	

Devices and Accessories

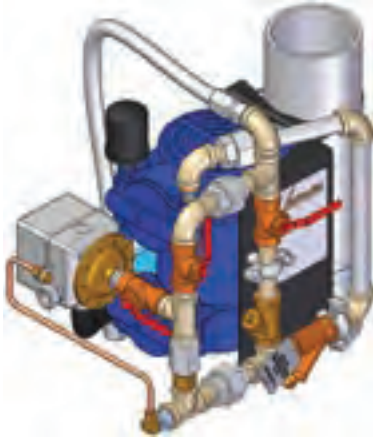

Air Maintenance/Compressor Assembly

SERIES 7C7

[Download publication 30.22](#) for complete information

- Features riser mounted compressor, Series 757P air maintenance device, and flexible hoses for installation

Certifications/Listings:



Electric/Pneumatic Double Interlock Actuator

SERIES 767

[Download publication 30.62](#) for complete information

- Designed for a single trip point for the pneumatic event, regardless of water supply pressure, and an integral electric solenoid
- Uses a ½" | DN15 NPT connection, wired for 24 VDC
- Pressures up to 300 psi | 2068 kPa | 21 bar

Certifications/Listings:

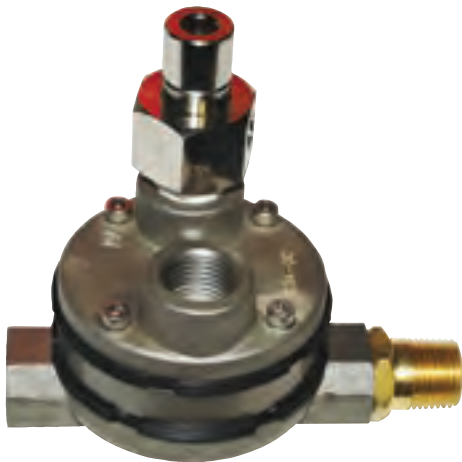

Low Pressure Actuator

SERIES 776

[Download publication 30.65](#) for complete information

- Designed for a single trip point for the pneumatic event, regardless of water supply pressure
- Comes standard on Series 768N dry, Series 769N deluge and Series 769N preaction FireLock NXT™ valves
- Pressures up to 300 psi | 2068 kPa | 21 bar

Certifications/Listings:





Double Pneumatic Actuator

SERIES 798

[Download publication 30.61](#) for complete information

- Designed to actuate at 7 psi | 48 kPa | 0.5 bar for both the pilot and sprinkler system
- Pressures up to 300 psi | 2068 kPa | 21 bar

Certifications/Listings:



FireLock™ Ball Check Valve

SERIES 748

[Download publication 30.44](#) for complete information

- Remains fully open allowing free flow of air until the sprinkler control valve is activated, at which time the flow of water entering the sprinkler system will close the ball check keeping the air supply trim from flooding
- Pressures up to 300 psi | 2068 kPa | 21 bar

Certifications/Listings:



FireLock™ Auto Drain

SERIES 749

[Download publication 30.43](#) for complete information

- Drains the diaphragm charge line, preventing the diaphragm from repressurizing
- Must manually reset after decay
- Pressures up to 300 psi | 2068 kPa | 21 bar

Certifications/Listings:



Devices and Accessories



Manual Release Panel

SERIES 755

[Download publication 30.41](#) for complete information

- Operates as a manually operated actuating device
- Contains a special quarter turn ball valve mounted in a painted steel enclosure
- Pressures up to 300 psi | 2068 kPa | 21 bar



FireLock™ Dry Accelerator

SERIES 746-LPA

[Download publication 30.64](#) for complete information

- Designed for Series 768N dry and Series 769N preaction valves in order to speed response time and/or accommodate larger system
- System air pressures ranging from 13 psi | 90 kPa | 0.9 bar to 18 psi | 124 kPa | 1.2 bar
- Pressures up to 300 psi | 2068 kPa | 21 bar

Certifications/Listings:



FireLock™ Retard Chamber

SERIES 752

[Download publication 30.31](#) for complete information

- Reduces the possibility of false alarms due to water supply pressure surges
- Designed for use with Victaulic® Series 751 alarm check valves
- Pressures up to 300 psi | 2068 kPa | 21 bar

Certifications/Listings:



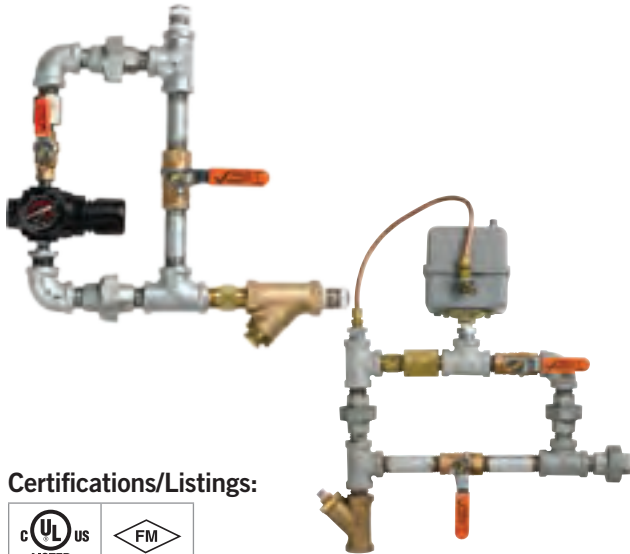

FireLock™ Air Maintenance Trim Assembly

SERIES 757 and 757P

[Download publication 30.35](#) and [30.36](#) for complete information

- Reduces high pressure supply air through the integral regulator to recommended air pressure based on the water supply pressure
- Series 757P designed with pressure switch for use with small compressors which do not have pressure control switches

Certifications/Listings:



Water Column Drain Kit

SERIES 75D

[Download publication 30.34](#) for complete information

- Automatically drains residual water in the riser above the clapper
- No operator maintenance or resetting is required
- Pressures up to 175 psi | 1207 kPa | 12 bar

Certifications/Listings:

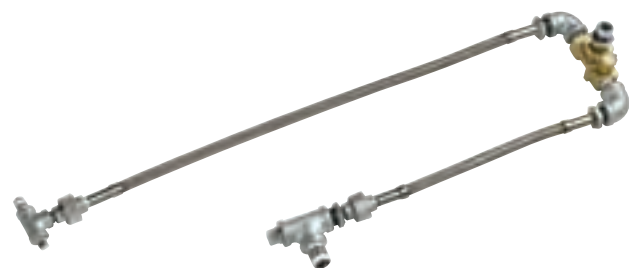

Supplemental Alarm Kit

SERIES 75B

[Download publication 30.33](#) for complete information

- Ensures that the mechanical alarm continues even if the clapper closes and water fills above it in the system
- Pressures up to 300 psi | 2068 kPa | 21 bar

Certifications/Listings:





Water Motor Alarm

SERIES 760

[Download publication 30.32](#) for complete information

- Mechanical, water-powered device signaling the flow of water in an automatic sprinkler system
- For wall thicknesses 2–13" | 51–330 mm
- Red enamel is standard finish for the gong shell

Certifications/Listings:















Hydraulic Control Valves

Through our exclusive partnership with Bermad, Victaulic now offers innovative solutions for the control and management of fire protection systems specifically as it relates to water supply and pressure control.

Designing fire protection systems for high-rise and high-demand buildings presents a unique set of challenges, all of which can be addressed by leveraging Bermad's product and technical expertise along with Victaulic's extensive system knowledge and support.

- Regional availability, contact [Victaulic](#) for details



Level Control Valves	page	Pressure Control Valves	page
 Modulating Horizontal Level Control Valve (Series 866-460)	48	 Pressure Reducing Control Valve (Series 867-42T)	49
 Bi-Level Electronic Level Control Valve (Series 866-465)	48	 Pressure Reducing Control Valve (Series 867-7UL)	50
 Bi-level Vertical Float Level Control Valve (Series 866-466)	48	 Pressure Reducing Control Valve (Series 867-400)	50
 Modulating Altitude Pilot Level Control Valve (Series 866-480)	49	 Pressure Relief Control Valve (Series 867-43T)	50
 Three-way Altitude Pilot Level Control Valve (Series 866-482)	49	 Pressure Relief Control Valve (Series 867-7UF)	51
		 Pressure Relief Control Valve with Electric Override (Series 867-759)	51
		 Pressure Relief Control Valve (Series 867-4UF)	51
		 Pressure Relief Control Valve with Electric Override (Series 867-459)	52



Modulating Horizontal Level Control Valve

SERIES 866-460

[Download publication 30.94](#) for complete information

- Hydraulically controlled, diaphragm actuated valve that controls reservoir filling to maintain constant water level, regardless of fluctuating demand
- Globe valve body
- Sizes 1½–12" | DN40–DN300
- Pressures up to 250 psi | 1724 kPa | 17 bar



Bi-Level Electronic Level Control Valve

SERIES 866-465

[Download publication 30.94](#) for complete information

- Hydraulically controlled, diaphragm actuated valve that controls reservoir filling in response to electric float switch signals
- Globe valve body
- Sizes 1½–12" | DN40–DN300
- Pressures up to 250 psi | 1724 kPa | 17 bar



Bi-level Vertical Float Level Control Valve

SERIES 866-466

[Download publication 30.94](#) for complete information

- Hydraulically controlled, diaphragm actuated control valve that controls reservoir filling in response to a hydraulic on-off float pressure commands
- Globe valve body
- Sizes 1½–12" | DN40–DN300
- Pressures up to 250 psi | 1724 kPa | 17 bar

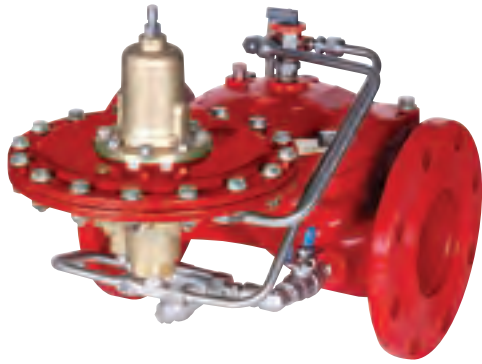

Modulating Altitude Pilot Level Control Valve

SERIES 866-480

[Download publication 30.94](#) for complete information

- Hydraulically controlled, diaphragm actuated valve that shuts off at a pre-set reservoir full level and opens in response to a sensor in the altitude pilot mounted on the main valve
- Globe valve body
- Sizes 1½–12" | DN40–DN300
- Pressures up to 250 psi | 1724 kPa | 17 bar

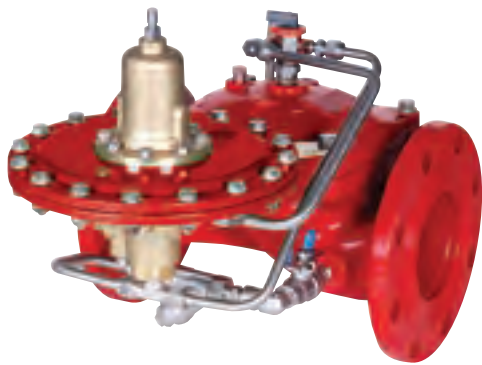

Three-way Altitude Pilot Level Control Valve

SERIES 866-482

[Download publication 30.94](#) for complete information

- Hydraulically controlled, diaphragm actuated valve that shuts off at a pre-set reservoir full level and opens in response to a sensor in the 3-way altitude pilot mounted on the main valve
- Globe valve body
- Sizes 1½–12" | DN40–DN300
- Pressures up to 250 psi | 1724 kPa | 17 bar



Pressure Reducing Control Valve

SERIES 867-42T

[Download publication 30.93](#) for complete information

- Low-flow stability without an anti-cavitation accessory
- Fully supported and reinforced diaphragm
- No obstructions in the flow path
- "Y" Pattern globe valve body
- Sizes 1½–10" | DN40–DN250
- Pressures up to 365 psi | 2517 kPa | 25 bar

Certifications/Listings:





Pressure Reducing Control Valve

SERIES 867-7UL

[Download publication 30.93](#) for complete information

- Double chamber actuator provides rapid response to changing system conditions
- Advanced actuator design increases operating life
- “Y” Pattern globe valve body
- Sizes 1½–16" | DN40–DN400
- Pressures up to 350 psi | 2413 kPa | 24 bar

Certifications/Listings:



Pressure Reducing Control Valve

SERIES 867-400

[Download publication 30.93](#) for complete information

- Proprietary reinforced rolling elastomeric diaphragm
- In-line serviceability, eliminates the need to remove for service
- Globe valve body
- Sizes 1½–12" | DN40–DN300
- Pressures up to 175 psi | 1207 kPa | 12 bar



Pressure Relief Control Valve

SERIES 867-43T

[Download publication 30.93](#) for complete information

- Low-flow stability without an anti-cavitation accessory
- Fully supported and reinforced diaphragm
- No obstructions in the flow path
- “Y” Pattern globe valve body
- Sizes 1½–10" | DN40–DN250
- Pressures up to 365 psi | 2517 kPa | 25 bar

Certifications/Listings:



Certifications/Listings:

Pressure Relief Control Valve

SERIES 867-7UF

[Download publication 30.93](#) for complete information

- Double chamber actuator provides rapid response to changing system conditions
- Advanced actuator design increases operating life
- “Y” Pattern globe valve body
- Sizes 1½–16" | DN40–DN400
- Pressures up to 350 psi | 2413 kPa | 24 bar



Pressure Relief Control Valve with Electric Override

SERIES 867-759

[Download publication 30.93](#) for complete information

- Double chamber actuator provides rapid response to changing system conditions
- Advanced actuator design increases operating life
- “Y” Pattern globe valve body
- Sizes 1½–16" | DN40–DN400
- Pressures up to 350 psi | 2413 kPa | 24 bar



Pressure Relief Control Valve

SERIES 867-4UF

[Download publication 30.93](#) for complete information

- Proprietary reinforced rolling elastomeric diaphragm
- In-line serviceability, eliminates the need to remove for service
- Globe valve body
- Sizes 1½–12" | DN40–DN300
- Pressures up to 175 psi | 1207 kPa | 12 bar

Certifications/Listings:



Pressure Relief Control Valve with Electric Override

SERIES 867-459

[Download publication 30.93](#) for complete information

- Proprietary reinforced rolling elastomeric diaphragm
- In-line serviceability, eliminates the need to remove for service
- Globe valve body
- Sizes 1½–12" | DN40–DN300
- Pressures up to 175 psi | 1207 kPa | 12 bar







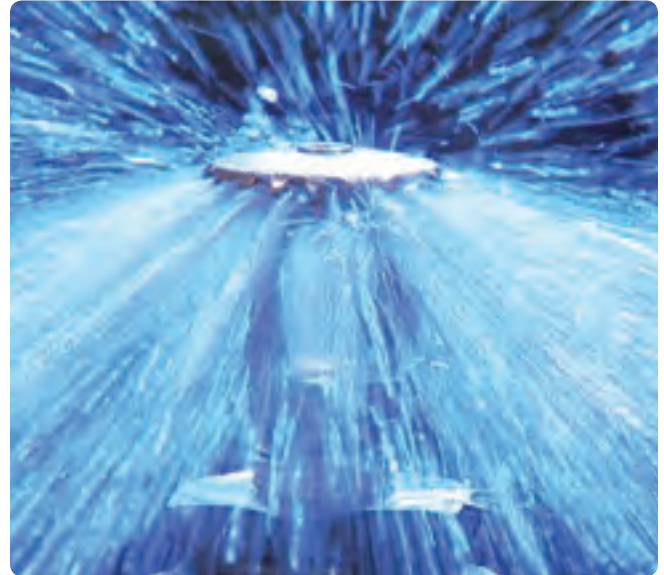

Automatic Sprinklers

Victaulic® FireLock™ sprinklers are designed for a wide variety of applications and are available with a wide range of finishes and temperature ratings, aesthetic and performance requirements.

Victaulic offers a complete line of accessories, guards, shields, escutcheons, expansion and cover plates – all designed to provide you with a single source for your next sprinkler project.



Category

	Standard Commercial	55–56
	Extended Coverage	57–58
	Storage	59–60
	Residential	61
	Specific Application	62
	Dry	63–64
	Nozzles	65
	Wrenches	66
	Accessories	66

page

Victaulic® FireLock™ Sprinklers

Easy and Safe Installation

Open-end, socket-style and recessed sprinkler wrenches are designed specifically for installing Victaulic sprinklers.

Innovative Design

New sprinkler models offer extended spray coverage with an aesthetically pleasing flat cover plate.

Proprietary Coatings

VC-250 is an optional, corrosion-resistant coating developed by Victaulic to increase the protection of *FireLock* sprinklers from visual and physical changes such as exposure to weather or exposure to areas that may be specified as chemical environments. When applied, this nickel based, multi-layer coating fully encompasses each *FireLock* sprinkler to provide increased corrosion resistance while maintaining functionality.

Available Temperature Ratings Table					
Victaulic® Part Identification	Temperature – °F °C		Sprinkler Temperature Classification	Glass Bulb Color	Solder Link Color
	Nominal Temp. Rating	Max. Ambient Temp. Allowed			
A ¹	135	100	Ordinary	Orange	
	57	38			
C	155	100	Ordinary	Red	
	68	38			
D ²	165	100	Ordinary		
	74	38			
E	175	150	Intermediate	Yellow	
	79	65			
F	200	150	Intermediate	Green	
	93	65			
G	212	150	Intermediate		Black with White Dot/White Arms
	100	65			
J	286	225	High	Blue	Black with Blue Dot/Blue Arms
	141	107			
K	360	300	Extra High ³	Purple	
	182	149			
M	Open			Open	Open
N	162	100	Ordinary		Black
	72	38			

¹ 138°F | 59°C per LPCB

² Cover for use with a Standard or Quick Response Concealed Sprinkler 175°F | 79°C or 200°F | 93°C

³ Standard response only.

Important Notes:

All glass bulbs are rated for temperatures from -67°F | -55°C up to those shown in adjacent table.

Not all temperatures are available with all styles of sprinklers. Consult individual product publication for specific information.

Standard Commercial



Note: Sprinkler approvals and listings can vary by model, temperature and finish. For complete regulatory information, consult the product publication.

Standard Response

Model/SIN	K-Factor Imp. S.I.	Hazard	Type	Response	Thread Size In.(NPT) mm	Temperature Rating F C (see below)	Certifications/ Listings	Sprinkler Finish	Max. Pressure PSI Bar	Wrench	Publication
V2401	4.2 6.1	LH	Upright	SR	3/8 10	135, 155, 175, 200, 286	cULus	B, CH, WH, BL, C, VC-250	175 12	V27, V27-2	40.87
V2403	4.2 6.1	LH	Pendent	SR	3/8 10	135, 155, 175, 200, 286	cULus	B, CH, WH, BL, C, VC-250	175 12	V27, V27-2	40.87
V2701	2.8 4.0	LH	Upright	SR	1/2 15	135, 155, 175, 200, 286, 360	cULus, FM	B, CH, WH, BL, C, VC-250	175 12	V27, V27-2	40.40
V2703	5.6 8.1	All	Upright	SR	1/2 15	135, 155, 175, 200, 286, 360	cULus, FM, VdS, LPCB, CE, CCCF	B, CH, WH, BL, C, VC-250	250 17	V27, V27-2	40.10
V2705	2.8 4.0	LH	Pendent	SR	1/2 15	135, 155, 175, 200, 286, 360	cULus	B, CH, WH, BL, C, VC-250	175 12	V27, V27-2	40.40
V2707	5.6 8.1	All	Pendent	SR	1/2 15	135, 155, 175, 200, 286, 360	cULus, FM, LPCB, CCCF	B, CH, WH, BL, C, VC-250	250 17	V27, V27-2	40.10
V2709	5.6 8.1	LH, OH	Horizontal Sidewall	SR	1/2 15	135, 155, 175, 200, 286, 360	cULus, FM, LPCB, CE, CCCF	B, CH, WH, BL, C, VC-250	250 17	V27, V27-2	40.11
V2725	5.6 8.1	OH	Conven- tional	SR	1/2 15	135, 155, 175, 200, 286, 360	cULus, VdS, LPCB, CE	B, CH, WH, N, VC-250	175 12	V27, V27-2	40.17
V2727	5.6 8.1	All	European Pendent	SR	1/2 15	135, 155, 175, 200, 286, 360	cULus, VdS, LPCB, CE	B, CH, WH, VC-250	175 12	V27, V27-2	40.18
V2753	5.6 8.1	All	Conven- tional	SR	1/2 15	135, 155, 175, 200, 286, 360	cULus	B, VC-250	300 21	V27, V27-2	40.27
V3401	8.0 11.5	All	Upright	SR	3/4 20	135, 155, 175, 200, 286, 360	cULus, FM, VdS, LPCB, CE	B, CH, WH, BL, C, VC-250	175 12	V34	40.15
V3405	8.0 11.5	All	Pendent	SR	3/4 20	135, 155, 175, 200, 286, 360	cULus, FM	B, CH, WH, BL, C, VC-250	175 12	V34	40.15
V3409	8.0 11.5	LH, OH	Horizontal Sidewall	SR	3/4 20	135, 155, 175, 200, 286, 360	cULus	B, CH, WH, BL, C, VC-250	175 12	V34	40.16
V3423	8.0 11.5	All	European Pendent	SR	3/4 20	135, 155, 175, 200, 286, 360	VdS, LPCB, CE	B, CH, WH, C, VC-250	175 12	V34	40.19
V3801	5.6 8.1	LH, OH	Concealed Pendent	SR	1/2 15	135, 155, 175, 200	cULus, LPCB, CE, CCCF	B, CH, WH, BL, C	175 12	V38-4, V38-5	40.50
V3807	5.6 8.1	LH, OH	Concealed Pendent	SR	1/2 15	135, 155, 175, 200	cULus	B, CH, WH, BL, C	300 21	V38-4, V38-5	40.55

Hazard Type		Response Type		Temperature Rating		Sprinkler Finishes	
Light Hazard	LH	Standard Response	SR	135°F	57°C	Plain Brass	B
Ordinary Hazard	OH	Quick Response	QR	155°F	68°C	Chrome plated	CH
LH, OH, Extra and Storage	All	Fast Response	FR	162°F	72°C	White painted	WH
Residential	Res	Open	Open	165°F	73°C	Black painted	BL
Specific Application	Spec			175°F	79°C	Custom	C
				200°F	93°C	VC-250	VC-250
				212°F	100°C		
				286°F	141°C		
				360°F	182°C		

Standard Commercial



Note: Sprinkler approvals and listings can vary by model, temperature and finish. For complete regulatory information, consult the product publication.

Quick Response

Model/ SIN	K-Factor Imp. S.I.	Hazard	Type	Response	Thread Size In.(NPT) mm	Temperature Rating F C	Certifications/ Listings	Sprinkler Finish	Max. Pressure PSI Bar	Wrench	Publication
V2402	4.2 6.1	LH	Upright	QR	3/8 10	135, 155, 175, 200, 286	cULus	B, CH, WH, BL, C, VC-250	175 12	V27, V27-2	40.87
V2404	4.2 6.1	LH	Pendent	QR	3/8 10	135, 155, 175, 200, 286	cULus	B, CH, WH, BL, C, VC-250	175 12	V27, V27-2	40.87
V2702	2.8 4.0	LH	Upright	QR	1/2 15	135, 155, 175, 200, 286	cULus, FM	B, CH, WH, BL, C, VC-250	175 12	V27, V27-2	40.40
V2704	5.6 8.1	All	Upright	QR	1/2 15	135, 155, 175, 200, 286	cULus, FM, VdS, LPCB, CE, CCCF	B, CH, WH, BL, C, VC-250	250 17	V27, V27-2	40.10
V2706	2.8 4.0	LH	Pendent	QR	1/2 15	135, 155, 175, 200, 286	cULus	B, CH, WH, BL, C, VC-250	175 12	V27, V27-2	40.40
V2708	5.6 8.1	All	Pendent	QR	1/2 15	135, 155, 175, 200, 286	cULus, FM, CCCF	B, CH, WH, BL, C, VC-250	250 17	V27, V27-2	40.10
V2710	5.6 8.1	LH, OH	Horizontal Sidewall	QR	1/2 15	135, 155, 175, 200, 286,	cULus, FM, LPCB, CE, CCCF	B, CH, WH, BL, C, VC-250	250 17	V27, V27-2	40.11
V2726	5.6 8.1	OH	Conven- tional	QR	1/2 15	135, 155, 175, 200, 286	cULus, VdS, LPCB, CE	B, CH, WH, VC-250	175 12	V27, V27-2	40.17
V2728	5.6 8.1	All	European Pendent	QR	1/2 15	135, 155, 175, 200, 286	cULus, VdS, LPCB, CE	B, CH, WH, VC-250	175 12	V27, V27-2	40.18
V2754	5.6 8.1	All	Conven- tional	QR	1/2 15	135, 155, 175, 200, 286, 360	cULus	B, VC-250	300 21	V27, V27-2	40.27
V3402	8.0 11.5	All	Upright	QR	3/4 20	135, 155, 175, 200, 286	cULus, FM, VdS, LPCB, CE, CCCF	B, CH, WH, BL, C, VC-250	175 12	V34	40.15
V3406	8.0 11.5	All	Recessed Pendent	QR	3/4 20	135, 155, 175, 200	cULus, FM, CCCF	B, CH, WH, BL, C, VC-250	175 12	V34	40.15
V3410	8.0 11.5	LH, OH	Horizontal Sidewall	QR	3/4 20	135, 155, 175, 200, 286	cULus	B, CH, WH, BL, C, VC-250	175 12	V34	40.16
V3424	8.0 11.5	All	European Pendent	QR	3/4 20	135, 155, 175, 200, 286	VdS, LPCB, CE	B, CH, WH, C, VC-250	175 12	V34	40.19
V3802	5.6 8.1	LH, OH	Concealed Pendent	QR	1/2 15	135, 155, 175, 200	cULus, FM, LPCB, CE, CCCF	B, CH, WH, BL, C	175 12	V38-4, V38-5	40.50
V3808	5.6 8.1	LH, OH	Concealed Pendent	QR	1/2 15	135, 155, 175, 200	cULus	B, CH, WH, BL, C	300 21	V38-4, V38-5	40.55

Hazard Type		Response Type		Temperature Rating		Sprinkler Finishes	
Light Hazard	LH	Standard Response	SR	135°F	57°C	Plain Brass	B
Ordinary Hazard	OH	Quick Response	QR	155°F	68°C	Chrome plated	CH
LH, OH, Extra and Storage	All	Fast Response	FR	162°F	72°C	White painted	WH
Residential	Res	Open	Open	165°F	73°C	Black painted	BL
Specific Application	Spec			175°F	79°C	Custom	C
				200°F	93°C	VC-250	VC-250
				212°F	100°C		
				286°F	141°C		
				360°F	182°C		

Extended Coverage



Note: Sprinkler approvals and listings can vary by model, temperature and finish. For complete regulatory information, consult the product publication.

Standard Response

Model/SIN	K-Factor Imp. S.I.	Hazard	Type	Response	Thread Size In.(NPT) mm	Temperature Rating F C	Certifications/Listings	Sprinkler Finish	Max. Pressure PSI Bar	Wrench	Publication
V3411	11.2 16.1	LH	Pendent	SR	¾ 20	135, 155, 175, 200	cULus, FM	B, CH, WH, BL, C, VC-250	175 12	V34	40.30
V3413	14.0 20.2	LH	Pendent	SR	¾ 20	135, 155, 175, 200	cULus, FM	B, CH, WH, BL, C, VC-250	175 12	V34	40.31
V3415	8.0 11.5	LH	Horizontal Sidewall	SR	¾ 20	135, 155, 175, 200	cULus, FM	B, CH, WH, BL, C, VC-250	175 12	V34	40.33
V3421	14.0 20.2	OH	Pendent	SR	¾ 20	155, 175, 200, 286	cULus	B, CH, WH, BL, C, VC-250	175 12	V34	40.34
V3425	14.0 20.2	OH	Upright	SR	¾ 20	155, 175, 200, 286	cULus	B, CH, WH, BL, C, VC-250	175 12	V34	40.34

Hazard Type		Response Type		Temperature Rating		Sprinkler Finishes	
Light Hazard	LH	Standard Response	SR	135°F	57°C	Plain Brass	B
Ordinary Hazard	OH	Quick Response	QR	155°F	68°C	Chrome plated	CH
LH, OH, Extra and Storage	All	Fast Response	FR	162°F	72°C	White painted	WH
Residential	Res	Open	Open	165°F	73°C	Black painted	BL
Specific Application	Spec			175°F	79°C	Custom	C
				200°F	93°C	VC-250	VC-250
				212°F	100°C		
				286°F	141°C		
				360°F	182°C		

Extended Coverage



Note: Sprinkler approvals and listings can vary by model, temperature and finish. For complete regulatory information, consult the product publication.

Quick Response											
Model/SIN	K-Factor Imp. S.I.	Hazard	Type	Response	Thread Size In.(NPT) mm	Temperature Rating F C	Certifications/ Listings	Sprinkler Finish	Max. Pressure PSI Bar	Wrench	Publication
V3102	8.0 11.2	LH	Concealed Pendent	QR	3/4 20	135	cULus	B, CH, WH, BL, C	175 12	V31, V33	40.76
V3104	11.2 16.1	LH	Concealed Pendent	QR	3/4 20	135	cULus	B, CH, WH, BL, C	175 12	V31, V33	40.76
V3412	11.2 16.1	LH	Pendent	QR	3/4 20	135, 155, 175, 200	cULus, FM	B, CH, WH, BL, C, VC-250	175 12	V34	40.30
V3414	14.0 20.2	LH	Pendent	QR	3/4 20	135, 155, 175, 200	cULus, FM	B, CH, WH, BL, C, VC-250	175 12	V34	40.31
V3416	8.0 11.5	LH	Horizontal Sidewall	QR	3/4 20	135, 155, 175, 200	cULus, FM	B, CH, WH, BL, C, VC-250	175 12	V34	40.33
V3428	8.0 11.5	LH	Pendent	QR	3/4 20	135, 155, 175, 200	cULus	B, CH, WH, C, VC-250	175 12	V34	40.78

Hazard Type		Response Type		Temperature Rating		Sprinkler Finishes	
Light Hazard	LH	Standard Response	SR	135°F	57°C	Plain Brass	B
Ordinary Hazard	OH	Quick Response	QR	155°F	68°C	Chrome plated	CH
LH, OH, Extra and Storage	All	Fast Response	FR	162°F	72°C	White painted	WH
Residential	Res	Open	Open	165°F	73°C	Black painted	BL
Specific Application	Spec			175°F	79°C	Custom	C
				200°F	93°C	VC-250	VC-250
				212°F	100°C		
				286°F	141°C		
				360°F	182°C		

Storage

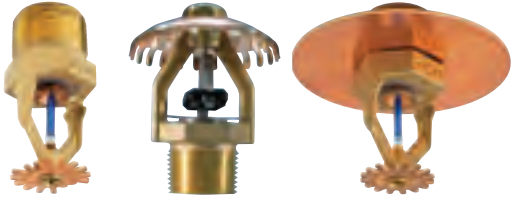

Note: Sprinkler approvals and listings can vary by model, temperature and finish. For complete regulatory information, consult the product publication.

Standard Response

Model/ SIN	K-Factor Imp. S.I.	Hazard	Type	Response	Thread Size In.(NPT) mm	Temperature Rating F C	Certifications/ Listings	Sprinkler Finish	Max. Pressure PSI Bar	Wrench	Publication
V2721	5.6 8.1	All	Upright	SR	½ 15	135, 155, 175, 200, 286	cULus, FM	B, VC-250	175 12	V27, V38	40.22
V2723	5.6 8.1	All	Pendent	SR	½ 15	135, 155, 175, 200, 286	cULus, FM	B, VC-250	175 12	V27, V38	40.22
V3403	11.2 16.1	All	Upright	SR	¾ 20	135, 155, 175, 200, 286	cULus, FM, CNBOP	B, CH, WH, VC-250	175 12	V44	40.20
V3407	11.2 16.1	All	Pendent	SR	¾ 20	135, 155, 175, 200, 286	cULus, FM, CNBOP	B, CH, WH, VC-250	175 12	V44	40.20
V3417	8.0 11.5	All	Upright	SR	¾ 20	135, 155, 175, 200, 286	cULus, FM	B, VC-250	175 12	V34	40.23
V3419	8.0 11.5	All	Pendent	SR	¾ 20	135, 155, 175, 200, 286	cULus, FM	B, VC-250	175 12	V34	40.23
V4601	25.2 36.8	All	CMSA Pendent	SR	1 25	162, 212, 286	cULus, FM, CNBOP	B	175 12	V46	40.95
V4603	25.2 36.8	All	CMSA Upright	SR	1 25	162, 212, 286	FM, CNBOP	B	175 12	V46	40.98

Hazard Type		Response Type		Temperature Rating		Sprinkler Finishes	
Light Hazard	LH	Standard Response	SR	135°F	57°C	Plain Brass	B
Ordinary Hazard	OH	Quick Response	QR	155°F	68°C	Chrome plated	CH
LH, OH, Extra and Storage	All	Fast Response	FR	162°F	72°C	White painted	WH
Residential	Res	Open	Open	165°F	73°C	Black painted	BL
Specific Application	Spec			175°F	79°C	Custom	C
				200°F	93°C	VC-250	VC-250
				212°F	100°C		
				286°F	141°C		
				360°F	182°C		

Storage

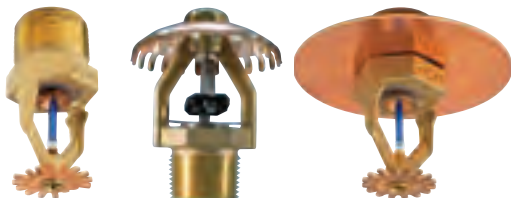

Note: Sprinkler approvals and listings can vary by model, temperature and finish. For complete regulatory information, consult the product publication.

Quick Response

Model/SIN	K-Factor Imp. S.I.	Hazard	Type	Response	Thread Size In.(NPT) mm	Temperature Rating F C	Certifications/ Listings	Sprinkler Finish	Max. Pressure PSI Bar	Wrench	Publication
V2722	5.6 8.1	All	Upright	QR	½ 15	135, 155, 175, 200, 286	cULus, FM	B, VC-250	175 12	V27, V38	40.22
V2724	5.6 8.1	All	Pendent	QR	½ 15	135, 155, 175, 200, 286	cULus, FM	B, VC-250	175 12	V27, V38	40.22
V3404	11.2 16.1	All	Upright	QR	¾ 20	135, 155, 175, 200, 286	cULus, FM, CNBOP	B, CH, WH, VC-250	175 12	V34	40.20
V3408	11.2 16.1	All	Pendent	QR	¾ 20	135, 155, 175, 200, 286	cULus, FM, CNBOP	B, CH, WH, VC-250	175 12	V34	40.20
V3418	8.0 11.5	All	Upright	QR	¾ 20	135, 155, 175, 200, 286	cULus, FM	B, VC-250	175 12	V34	40.23
V3420	8.0 11.5	All	Pendent	QR	¾ 20	135, 155, 175, 200, 286	cULus, FM	B, VC-250	175 12	V34	40.23

Fast Response

Model/SIN	K-Factor Imp. S.I.	Hazard	Type	Response	Thread Size In.(NPT) mm	Temperature Rating F C	Certifications/ Listings	Sprinkler Finish	Max. Pressure PSI Bar	Wrench	Publication
V4702	16.8 24.25	All	ESFR Pendent	FR	¾ 20	155, 200	cULus, FM	B	175 12	V44/47	40.89

Hazard Type		Response Type		Temperature Rating		Sprinkler Finishes	
Light Hazard	LH	Standard Response	SR	135°F	57°C	Plain Brass	B
Ordinary Hazard	OH	Quick Response	QR	155°F	68°C	Chrome plated	CH
LH, OH, Extra and Storage	All	Fast Response	FR	162°F	72°C	White painted	WH
Residential	Res	Open	Open	165°F	73°C	Black painted	BL
Specific Application	Spec			175°F	79°C	Custom	C
				200°F	93°C	VC-250	VC-250
				212°F	100°C		
				286°F	141°C		
				360°F	182°C		

Residential



Note: Sprinkler approvals and listings can vary by model, temperature and finish. For complete regulatory information, consult the product publication.

Quick Response

Model/SIN	K-Factor Imp. S.I.	Hazard	Type	Response	Thread Size In.(NPT) mm	Temperature Rating F C	Certifications/ Listings	Sprinkler Finish	Max. Pressure PSI Bar	Wrench	Publication
V2738	4.2 6.0	Res	Horizontal Sidewall	QR	½ 15	155, 175	cULus	B, CH, WH, BL, C, VC-250	175 12	V27, V27-2	40.54
V2740	4.9 7.1	Res	Pendent	QR	½ 15	155, 175	cULus	B, CH, WH, C, VC-250	175 12	V27, V27-1	40.47
V2742	4.9 7.1	Res	Concealed Pendent	QR	½ 15	155	cULus	CH, WH, BL, C, VC-250	175 12	V39, V27-2	40.52
V2744	5.6 8.1	Res	Horizontal Sidewall	QR	½ 15	155, 175	cULus	B, CH, WH, C, VC-250	175 12	V27, V27-2	40.49
V2902	6.9 9.9	Res	Pendent	QR	½ 15	155	cULus	B, CH, WH, BL, C	175 12	V29	40.44
V3426	6.9 9.9	Res	Pendent	QR	¾ 20	155, 175	cULus	B, CH, WH, C, VC-250	175 12	V34	40.48
V3806	5.6 8.1	Res	Concealed Pendent	QR	½ 15	155	cULus	B, CH, WH, BL, C	175 12	V38-4	40.43

Hazard Type		Response Type		Temperature Rating		Sprinkler Finishes	
Light Hazard	LH	Standard Response	SR	135°F	57°C	Plain Brass	B
Ordinary Hazard	OH	Quick Response	QR	155°F	68°C	Chrome plated	CH
LH, OH, Extra and Storage	All	Fast Response	FR	162°F	72°C	White painted	WH
Residential	Res	Open	Open	165°F	73°C	Black painted	BL
Specific Application	Spec			175°F	79°C	Custom	C
				200°F	93°C	VC-250	VC-250
				212°F	100°C		
				286°F	141°C		
				360°F	182°C		

Specific Application



Note: Sprinkler approvals and listings can vary by model, temperature and finish. For complete regulatory information, consult the product publication.

Quick Response											
Model/ SIN	K-Factor Imp. S.I.	Hazard	Type	Response	Thread Size In.(NPT) mm	Temperature Rating F C	Certifications/ Listings	Sprinkler Finish	Max. Pressure PSI Bar	Wrench	Publication
V2502	4.2 6.1	Spec	Upright	QR	1/2 15	175	cULus	B	175 12	V25	40.09

Hazard Type		Response Type		Temperature Rating		Sprinkler Finishes	
Light Hazard	LH	Standard Response	SR	135°F	57°C	Plain Brass	B
Ordinary Hazard	OH	Quick Response	QR	155°F	68°C	Chrome plated	CH
LH, OH, Extra and Storage	All	Fast Response	FR	162°F	72°C	White painted	WH
Residential	Res	Open	Open	165°F	73°C	Black painted	BL
Specific Application	Spec			175°F	79°C	Custom	C
				200°F	93°C	VC-250	VC-250
				212°F	100°C		
				286°F	141°C		
				360°F	182°C		

Automatic Sprinklers

Dry



Note: Sprinkler approvals and listings can vary by model, temperature and finish. For complete regulatory information, consult the product publication.

Standard Response

Model/SIN	K-Factor Imp. S.I.	Hazard	Type	Response	Thread Size In.(NPT) mm	Temperature Rating F C	Certifications/ Listings	Sprinkler Finish	Max. Pressure PSI Bar	Wrench	Publication
V3301	5.6 8.1	LH, OH	Concealed Pendent	SR	1 25	135, 155, 200	cULus	B, CH, WH, BL, C	175 12	V33	40.68
V3303	8.0 11.2	LH, OH	Concealed Pendent	SR	1 25	135, 155, 200	cULus	B, CH, WH, BL, C	175 12	V33	40.69
V3505	5.6 8.1	LH, OH	VicFlex™ Style VS1 Pendent	SR	1 25	135, 155, 175, 200, 286	cULus	WH, VC-250	175 12	—	10.91
V3509	5.6 8.1	LH, OH	Style VS1 Horizontal Sidewall	SR	1 25	135, 155, 175, 200, 286	cULus	WH, VC-250	175 12	—	10.91
V3517	5.6 8.1	LH, OH	Style VS1 Concealed Pendent	SR	1 25	135, 155, 175, 200	cULus	WH, VC-250	175 12	—	10.91
V3601	5.6 8.1	All	Upright	SR	1 25	135, 155, 200, 286	cULus, FM	B, CH, WH, BL, C, VC-250	175 12	V36	40.62
V3603	8.0 11.2	All	Upright	SR	1 25	135, 155, 200, 286	cULus, FM	B, CH, WH, BL, C, VC-250	175 12	V36	40.63
V3605	5.6 8.1	All	Pendent	SR	1 25	135, 155, 200, 286	cULus, FM	B, CH, WH, BL, C, VC-250	175 12	V36	40.60
V3607	8.0 11.2	All	Pendent	SR	1 25	135, 155, 200, 286	cULus, FM	B, CH, WH, BL, C, VC-250	175 12	V36	40.61
V3609	5.6 8.1	LH	Horizontal Sidewall	SR	1 25	135, 155, 200, 286	cULus, FM	B, CH, WH, BL, C, VC-250	175 12	V36	40.64
V3611	8.0 11.2	LH, OH	Horizontal Sidewall	SR	1 25	135, 155, 200, 286	cULus	B, CH, WH, BL, C, VC-250	175 12	V36	40.65

Dry type sprinklers are available in a variety configurations (Flush Mount, Sleeve and Skirt, Plain Barrel, Intermediate, Extended, Recessed). Please refer to the individual product publications for specific details.

Hazard Type		Response Type		Temperature Rating		Sprinkler Finishes	
Light Hazard	LH	Standard Response	SR	135°F	57°C	Plain Brass	B
Ordinary Hazard	OH	Quick Response	QR	155°F	68°C	Chrome plated	CH
LH, OH, Extra and Storage	All	Fast Response	FR	162°F	72°C	White painted	WH
Residential	Res	Open	Open	165°F	73°C	Black painted	BL
Specific Application	Spec			175°F	79°C	Custom	C
				200°F	93°C	VC-250	VC-250
				212°F	100°C		
				286°F	141°C		
				360°F	182°C		

Dry



Note: Sprinkler approvals and listings can vary by model, temperature and finish. For complete regulatory information, consult the product publication.

Quick Response											
Model/SIN	K-Factor Imp. S.I.	Hazard	Type	Response	Thread Size In.(NPT) mm	Temperature Rating F C	Certifications/ Listings	Sprinkler Finish	Max. Pressure PSI Bar	Wrench	Publication
V3302	5.6 8.1	LH, OH	Concealed Pendent	QR	1 25	135, 155, 200	cULus	B, CH, WH, BL, C	175 12	V33	40.68
V3304	8.0 11.2	LH, OH	Concealed Pendent	QR	1 25	135, 155, 200	cULus	B, CH, WH, BL, C	175 12	V33	40.69
V3506	5.6 8.1	LH, OH	VicFlex™ Style VS1 Pendent	QR	1 25	135, 155, 175, 200, 286	cULus	WH, VC-250	175 12	—	10.91
V3510	5.6 8.1	LH, OH	Style VS1 Horizontal Sidewall	QR	1 25	135, 155, 175, 200, 286	cULus	WH, VC-250	175 12	—	10.91
V3518	5.6 8.1	LH, OH	Style VS1 Concealed Pendent	QR	1 25	135, 155, 175, 200	cULus	WH, VC-250	175 12	—	10.91
V3602	5.6 8.1	All	Upright	QR	1 25	135, 155, 200, 286	cULus, FM	B, CH, WH, BL, C, VC-250	175 12	V36	40.62
V3604	8.0 11.2	All	Upright	QR	1 25	135, 155, 200, 286	cULus, FM	B, CH, WH, BL, C, VC-250	175 12	V36	40.63
V3606	5.6 8.1	All	Pendent	QR	1 25	135, 155, 200, 286	cULus, FM	B, CH, WH, BL, C, VC-250	175 12	V36	40.60
V3608	8.0 11.2	All	Pendent	QR	1 25	135, 155, 200, 286	cULus, FM	B, CH, WH, BL, C, VC-250	175 12	V36	40.61
V3610	5.6 8.1	LH	Horizontal Sidewall	QR	1 25	135, 155, 200, 286	cULus, FM	B, CH, WH, BL, C, VC-250	175 12	V36	40.64
V3612	8.0 11.2	LH, OH	Horizontal Sidewall	QR	1 25	135, 155, 200, 286	cULus	B, CH, WH, BL, C, VC-250	175 12	V36	40.65

Dry type sprinklers are available in a variety configurations (Flush Mount, Sleeve and Skirt, Plain Barrel, Intermediate, Extended, Recessed). Please refer to the individual product publications for specific details.

Hazard Type		Response Type		Temperature Rating		Sprinkler Finishes	
Light Hazard	LH	Standard Response	SR	135°F	57°C	Plain Brass	B
Ordinary Hazard	OH	Quick Response	QR	155°F	68°C	Chrome plated	CH
LH, OH, Extra and Storage	All	Fast Response	FR	162°F	72°C	White painted	WH
Residential	Res	Open	Open	165°F	73°C	Black painted	BL
Specific Application	Spec			175°F	79°C	Custom	C
				200°F	93°C	VC-250	VC-250
				212°F	100°C		
				286°F	141°C		
				360°F	182°C		

Nozzles

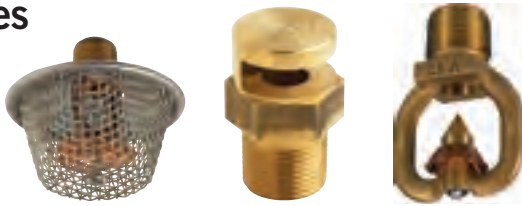

Note: Sprinkler approvals and listings can vary by model, temperature and finish. For complete regulatory information, consult the product publication.

Open Response

Model/SIN	K-Factor Imp. S.I.	Hazard	Type	Response	Thread Size In.(NPT) mm	Temperature Rating F C	Certifications/ Listings	Sprinkler Finish	Max. Pressure PSI Bar	Wrench	Publication
V1001	1.4 2.0	—	Window Sprinkler	Open	½ 15	Open	cULus, CNBOP	B, CH	175 12	V27	40.72
V1003	2.0 2.9	—	Window Sprinkler	Open	½ 15	Open	cULus, CNBOP	B, CH	175 12	V27	40.72
V1005	2.8 4.0	—	Window Sprinkler	Open	½ 15	Open	cULus, CNBOP	B, CH	175 12	V27	40.72
V1007	4.2 5.9	—	Window Sprinkler	Open	½ 15	Open	cULus, CNBOP	B, CH	175 12	V27	40.72
V1009	5.6 8.1	—	Window Sprinkler	Open	½ 15	Open	cULus, CNBOP	B, CH	175 12	V27	40.72
V1011	8.0 11.5	—	Window Sprinkler	Open	½ 15	Open	cULus, CNBOP	B, CH	175 12	V27	40.72
V1013	11.5 16.3	—	Window Sprinkler	Open	½ 15	Open	cULus, CNBOP	B, CH	175 12	V27	40.72
V2601	2.8 4.0	—	Foam Nozzle	Open	½ 15	Open	cULus	B	175 12	V26	40.73
V2603	5.6 8.1	—	Foam Nozzle	Open	½ 15	Open	cULus	B	175 12	V26	40.73
V1201 - V1278	1.2 – 7.2 1.7 – 10.4	—	Open Spray Nozzle	Open	½ 15	Open	cULus, FM, CNBOP	B, VC-250	175 12	V27	40.96

Hazard Type		Response Type		Temperature Rating		Sprinkler Finishes	
Light Hazard	LH	Standard Response	SR	135°F	57°C	Plain Brass	B
Ordinary Hazard	OH	Quick Response	QR	155°F	68°C	Chrome plated	CH
LH, OH, Extra and Storage	All	Fast Response	FR	162°F	72°C	White painted	WH
Residential	Res	Open	Open	165°F	73°C	Black painted	BL
Specific Application	Spec			175°F	79°C	Custom	C
				200°F	93°C	VC-250	VC-250
				212°F	100°C		
				286°F	141°C		
				360°F	182°C		

Wrenches



Wrench Model														
Wrench Type	Model V25	Model V26 Foam Nozzle	Model V27	Model V27-2	Model V29 Flush	Model V29-1	Model V33	Model V34	Model V36	Model V38-4	Model V38-5 Cabinet Socket	Model V39	Model V44/V47	Model V46
Open End	•	•	•					•	•				•	•
Recessed				•				•	•					
Socket					•	•	•			•	•			
Flush					•	•								
Concealed				•			•		•	•	•	•		

[Download publication 40.80](#) for complete information

Accessories



Sprinkler Guards

[Download publication 40.83](#) for complete information



Sprinkler Storage Cabinet

[Download publication 40.81](#) for complete information



Expansion Plate

[Download publication 40.84](#) for complete information



Sprinkler Escutcheon

[Download publication 40.88](#) for complete information

Victaulic Vortex™

The *Victaulic Vortex* fire suppression system is built on Victaulic® innovation and product development experience and provides the best capabilities of both water mist and inert gas systems. The homogeneous mixture of water droplets and nitrogen gas is discharged with enough energy to overcome the drag effect that has limited the effectiveness of traditional water mist systems.

The *Victaulic Vortex* system utilizes an active release system to discharge nitrogen upon activation. The average *Victaulic Vortex* droplet size is around 10 microns, and the minimal amount of water released per emitter is as little as ¼ gallon or 1 litre per minute. The system virtually eliminates any wetting in a space and uses 97% less water than high-pressure water mist systems. No costly clean up or equipment replacement.

The only hybrid nitrogen-water fire suppression system with:

- Green design that is safe for the environment and personnel
- Quick system recharge; minimal facility downtime
- No need for assurance of tight room integrity

**Victaulic Vortex****page***Victaulic Vortex 500*

68

*Victaulic Vortex 1000*

68

*Victaulic Vortex 1500*

68

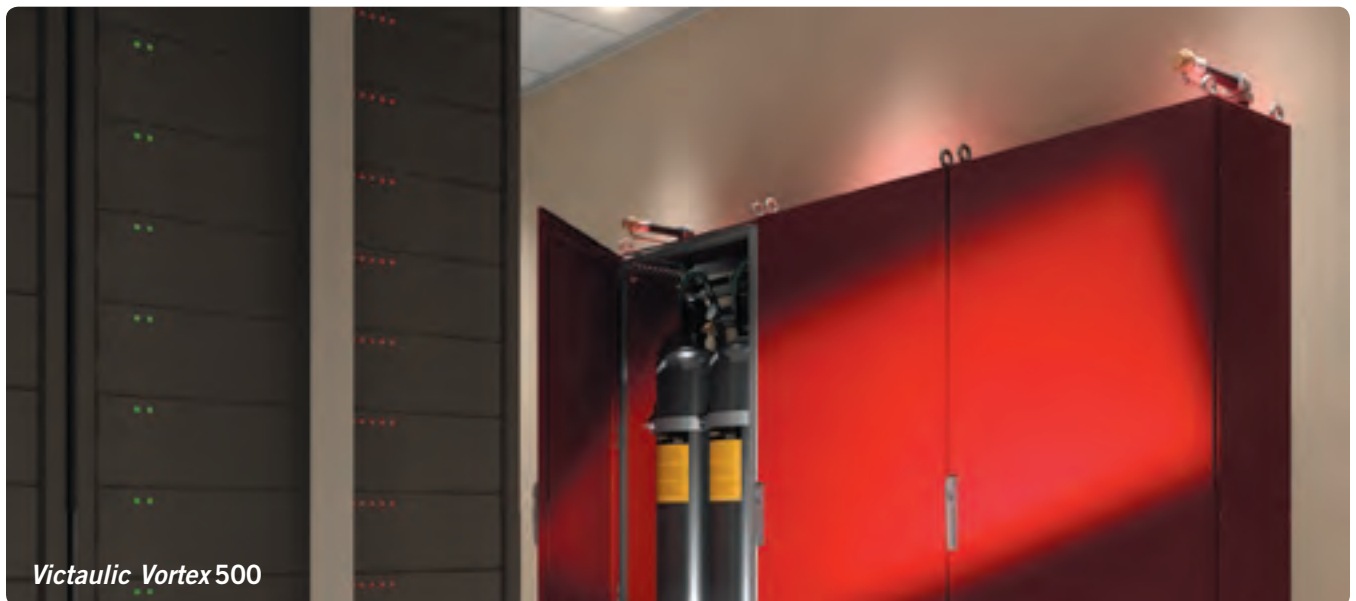
*Victaulic Vortex 500*



Victaulic Vortex™ 500 Fire Suppression System

[Download publication 70.10](#) for complete information

- Self-contained, requiring no additional piping once placed in the risk area
- Maximum elevation above sea level: 10,000 ft | 3,048 m
- Enclosure Volume: 500–6,100 ft³ | 14–173 m³

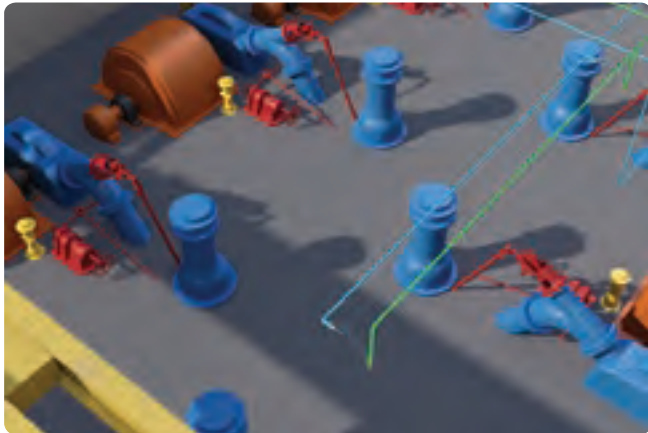

Victaulic Vortex™ 1000 Fire Suppression System

[Download publication 70.01](#) for complete information

- FM Approved in accordance with the FMCL-5580 standard for Fixed Extinguishing Systems, Hybrid (Water and Inert Gas) for the protection of combustion turbines, machinery spaces, and special hazard machinery spaces in enclosures with volumes not exceeding 127,525 ft³ | 3600 m³ and a maximum height of 24.6 ft | 7.5 m
- Touchscreen interface provides a simplified view into the operational aspects of the system

Approvals/Listings:



Victaulic Vortex™ 1500 Fire Suppression System

[Download publication 70.06](#) for complete information

- Can effectively be applied in total flooding fire suppression applications in the following areas: Industrial machine spaces such as power generation plants, turbine enclosures, automotive manufacturing, steel foundry, flammable liquids storage, data centers, museums, libraries, or mining facilities
- Touchscreen interface provides a simplified view into the operational aspects of the system

Specialty Systems

For special fire protection applications, Victaulic® delivers a variety of piping product solutions. From plain end HDPE, stainless steel and carbon steel, to grooved AWWA size ductile iron, carbon steel and stainless steel piping, whatever your need Victaulic has a full line of products to make the installation faster, easier and more economical.

Victaulic provides a variety of joining systems and materials for almost any fire protection application. Victaulic products are designed to meet the needs of the most demanding systems.







For the most up-to-date information on our specialty line of products please visit the Victaulic web site at victaulic.com.

Vic-Press™ stainless steel press tool PFT510



Specialty Systems

page

	Vic-Press™ for Schedule 10S Stainless Steel Piping	70
	Plain End Piping System	70
	The Refuse-to-Fuse™ System for HDPE Pipe	71
	Copper Piping System	71
	Stainless Steel Piping System	72
	AWWA Piping Systems for North America	72



Vic-Press™ for Schedule 10S Stainless Steel Piping

For the most up-to-date information please visit victaulic.com/vicpress

Revolutionary *Vic-Press* technology is now globally available for use on ASTM A-312 Schedule 10S stainless steel pipe. The *Vic-Press* for Schedule 10S system features an established and reliable technology that does not require special pipe. *Vic-Press* is now available for standard off-the-shelf stainless steel pipe, providing quick, easy and safe installation and maintenance.

Approvals/Listings:



Plain End Piping System

For the most up-to-date information please visit victaulic.com

The Victaulic® plain end piping method is ideal for maintenance and repairs as well as new system installation. *Roust-A-Bout* couplings and plain end fittings are UL and ULC Listed for fire protection services.

Victaulic plain end couplings are primarily designed for use on standard weight steel pipe (Schedule 40), but may be used on lightwall steel or other metallic pipe such as aluminum or stainless steel. No special pipe end preparation is necessary.

They are not intended for use on plastic pipe, plastic-coated pipe or brittle pipe, such as asbestos cement or cast iron. Nor are they intended for use on pipe with a surface hardness greater than 150 Brinell.

Approvals/Listings:



Specialty Systems



The Refuse-to-Fuse™ System for HDPE Pipe

For the most up-to-date information please visit refuse-to-fuse.com

The Refuse-to-Fuse™ System joins high density polyethylene pipe (HDPE) up to 10 times faster than traditional fusing with simple hand tools in any weather condition. Designed to be buried and FM Approved for Underground Fire Service Mains.

Approvals/Listings:



Copper Piping System

For the most up-to-date information please visit victaulic.com

The Victaulic grooved copper system offers a full line of couplings, Installation-Ready™ fittings, fittings, flange adapters and valves rated up to 300 psi | 2068 kPa | 20 bar. The copper connection system joins 2–8" | DN50–DN200 copper.

Approvals/Listings:





Stainless Steel Piping System

For the most up-to-date information please visit victaulic.com

For fast, economical joining of Schedule 5, 10, 20, and 40 stainless steel pipe, you will find a complete line of roll or cut grooved stainless mechanical pipe joining products from Victaulic®.

Approvals/Listings:



AWWA Piping Systems for North America

For the most up-to-date information please visit victaulic.com

The Victaulic grooved system for AWWA pipe offers a full line of couplings, fittings, flange adapters and valves for use on AWWA C-606 class 53 pipe or heavier and have a pressure rating of up to 500 psi | 3447 kPa | 34 bar combined with a size range from 3–36" | DN80–DN900.

Approvals/Listings:



Pipe Preparation Tools

Roll Groove

Victaulic was the first to develop roll grooving tools in the 1950's and continues to lead the industry in developing tools that make the job faster and easier to install.

Victaulic was the first company to receive approval for use of grooved pipe on fire protection systems.

Victaulic offers a variety of tools for pipe preparation, cutting holes, in-place repairs and system maintenance.



Roll groove shown on Schedule 40 steel pipe. The small dimple created on the interior pipe wall does not significantly affect pressure or flow.

Roll Grooving Process

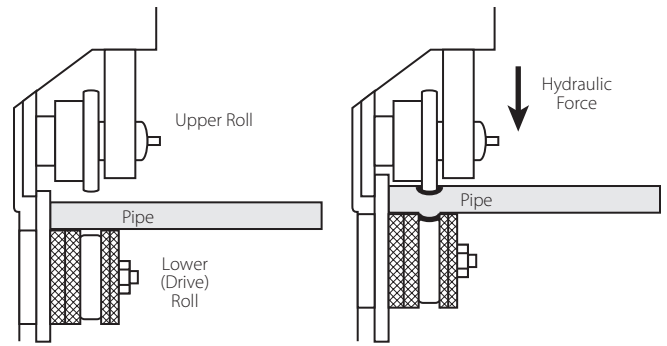

Vic-Easy tools cold form groove into pipe – maintains dimensions

Roll grooving removes no metal from pipe

Field Portable Roll Grooving Tools

	page
 VE12	74
 VE26	74
 VE46	75
 VE226	75

Field Fabrication Roll Grooving Tools

	page
 VE106/107	76
 VE206	76
 VE272SFS	77
 VE270FSD/VE271FSD	77
 VE416FSD/VE417FSD	78
 RG2100	78

Plant/Shop Fabrication Roll Grooving Tools

	page
 VE268	79
 RG5200i	79

Cut Grooving Tools

	page
 VG28GD	80
 VG	80



Vic-Press™ Tools

	page
 PFT510	81

Hole Cutting Tools

	page
 HCT908	81
 VHCT900	82
 VIC-TAP II	82

Tool Accessories

	page
 VPD752	83
 Power Mule II	83
 VAPS112	83

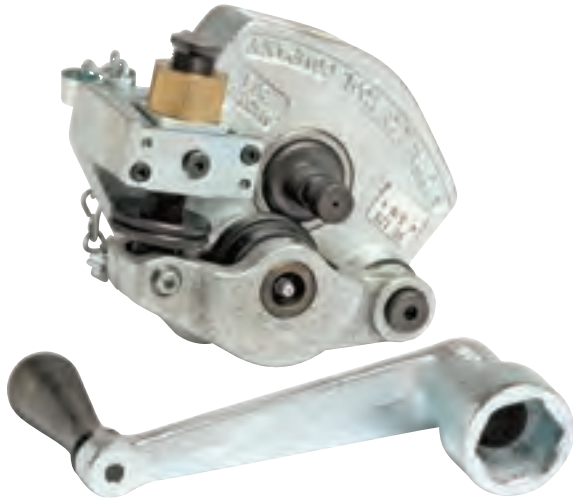

Field Portable Roll Grooving Tools

VE12 GROOVE IN-PLACE

[Download publication 24.01](#) for complete information

- Roll grooves $\frac{3}{4}$ –2" | DN20–DN50 pipe
- For manual grooving of Schedule 5, 10 and 40 steel; stainless steel; aluminum and PVC pipe
- Tool is manually operated using the supplied crank
- Enhanced tracking rolls allow bi-directional grooving
- Power Requirements: None
- Weight: 17 lbs. | 8 kg

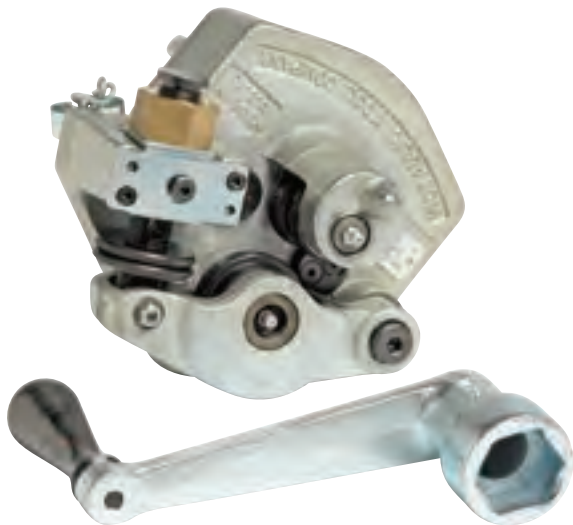

Field Portable Roll Grooving Tools

VE26 GROOVE IN-PLACE

[Download publication 24.01](#) for complete information

- Roll grooves 2–6" | DN50–DN150 pipe
- For manual grooving of Schedule 5, 10 and 40 steel; stainless steel; aluminum and PVC pipe; K, L, M, DWV, A, B and D copper tube
- Tool is manually operated using the supplied crank
- Enhanced tracking rolls allow bi-directional grooving
- Optional power drive adapter kit available to alternately groove pipe using a Ridgid® 300 power drive or VPD752
- Power Requirements: None
- Weight: 22 lbs. | 10 kg

Pipe Preparation Tools



Field Portable Roll Grooving Tools

VE46 GROOVE IN-PLACE

[Download publication 24.01](#) for complete information

- Roll grooves 3½–6" | DN90–DN150 pipe
- For manual grooving of Schedule 5, 10 and 40 steel; stainless steel and aluminum pipe; Schedule 40 – 80 PVC pipe
- Tool is manually operated using the supplied crank
- Enhanced tracking rolls allow bi-directional grooving and helps to hold the tool on the pipe end during the roll grooving process
- Optional power drive adapter kit available to alternately groove pipe using a Ridgid® 300 Power Drive or VPD752
- Power Requirements: None
- Weight: 28lbs. | 13 kg



Field Portable Roll Grooving Tools

VE226 PORTABLE GROOVER

[Download publication 24.01](#) for complete information

- Roll grooves ¾–6" | DN20–DN150 pipe
- For grooving of Schedule 5, 10 and 40 steel; stainless steel; aluminum and PVC pipe; K, L, M, DWV, A, B and D copper tube
- Tool is operated using a standard ¾" | 9.5 mm square ratchet drive (not included)
- Drive Requirements: Mounts to Victaulic® VPD752 or Ridgid® 300 Power Drive; optional bases available
- Weight: 37 lbs. | 17 kg



Field Fabrication Roll Grooving Tools

VE106/VE107 GROOVE-N-GO

[Download publication 24.01](#) for complete information

- Roll grooves 1¼–6" | DN32–DN150 pipe
- For grooving of Schedule 5, 10 and 40 steel and stainless steel pipe; K, L, M and DWV copper tube
- Mobile light-duty roll grooving tool with an integral motor/drive unit mounted to portable hand truck
- Reduces pipe handling by allowing the tool to be wheeled directly to the pipe preparation site
- ⅜" | 9.5 mm square ratchet drive for operation (standard)
- Enhanced tracking rolls help to keep the pipe on the tool during the roll grooving process
- Completely self-contained unit with an integral motor, safety foot switch and power plug
- Power Requirements:
VE106 is provided with 110 volt, 15 amp power;
VE107 is provided with 220 volt, 6 amp power
- Weight: 140 lbs. | 64 kg



Portable Roll Groover

STYLE VE206

[Download publication 24.01](#) for complete information

- Roll grooves 1¼–6" | DN32–DN150
- For grooving of Schedule 5, 10 and 40 steel and stainless steel pipe; K, L, M and DWV copper tube
- Tool head mounts to any tripod stand with a Ridgid® 300 bolt pattern or the flat bed of a work truck
- Hydraulic hand pump can be mounted on either side of the tool for right or left hand operation
- Supplied with Victaulic® tool carry bag for accessory storage
- Power Requirements: Compatible with multiple power drive units; Victaulic VPD752, Ridgid® 300 or 700 and Rems Amigo II
- Weight: 165 lbs. | 75 kg

Pipe Preparation Tools



Field Fabrication Roll Grooving Tools

VE272SFS

[Download publication 24.01](#) for complete information

- Roll grooves ¾ – 12" | DN20 – DN300 pipe
- For grooving of Schedule 5, 10, 40 and 80 steel; stainless steel; aluminum and PVC pipe; K, L, M and DWV copper tube
- Hand pump operation with a unique pivot arm design reduces handle effort
- Enhanced tracking rolls help to keep the pipe on the tool during the roll grooving process
- The fully-motorized, semi-automatic, electrohydraulic tool comes complete with safety guards and safety foot switch
- Power Requirements: Victaulic® VPD752 or Ridgid® 300 Power Drive
- Weight: 184 lbs. | 84 kg



Field Fabrication Roll Grooving Tools

VE270FSD/VE271FSD

[Download publication 24.01](#) for complete information

- Roll grooves ¾ – 12" | DN20 – DN300 pipe
- For grooving of Schedule 5, 10, 40 and 80 steel; stainless steel; aluminum and PVC pipe; K, L, M and DWV copper tube
- Completely self-contained unit with integral gear motor, safety guards, safety foot switch and power cord/plug
- Equipped with a unique pivot arm design, making roll changing quick and easy without removing shafts
- Enhanced tracking rolls help to keep the pipe on the tool during the roll grooving process
- The fully-motorized, semi-automatic, electrohydraulic tool comes complete with safety guards and safety foot switch
- Power Requirements: VE270FSD is provided with 110 volt, 15 amp power; VE271FSD is provided with 220 volt, 6 amp power
- Weight: 340 lbs. | 154 kg

Certifications/Listings:





Field Fabrication Roll Grooving Tools

VE416FSD/VE417FSD

[Download publication 24.01](#) for complete information

- Roll grooves 2–16" | DN50–DN400 pipe
- For grooving of Schedule 5, 10, 40 and 80 steel; stainless steel; aluminum and PVC pipe; K, L, M and DWV copper tube
- VE416FSD/VE417FSD is designed for field grooving of OGS pipe and should not be used for continuous field production grooving; For field production grooving capabilities, use a VE450FSD tool
- Groove depth adjuster allows for easy adjustment for initial groove diameter
- Completely self-contained units with integral gear motors, safety foot switch and power cord/plug
- The fully-motorized, semi-automatic, electrohydraulic tool comes complete with safety guards and safety foot switch
- Power Requirements: VE416FSD is provided with 110 volt, 15 amp for integral gear motor; VE417FSD is provided with 220 volt, 8 amp service
- Weight: 340 lbs. | 154 kg

Certifications/Listings:



FireLock™ IGS Roll Grooving Tool

RG2100

[Download publication 10.54](#) for complete information

- Optimized to roll groove IGS 1" | DN25 carbon steel Schedule 40 down to Schedule 10 pipe
- Features a cast carriage for use on a standard Ridgid™ 300 Power Drive
- Carriage accepts:
 - RG2100 tool head
 - Cutter
 - Reamer
 - Lever
- Power Requirements: 115 volt, 15 amp power connection
- Weight: 37.5 lbs | 17 kg
- Grooves to the proprietary IGS groove specification, [download publication 25.14](#)

Pipe Preparation Tools



Plant/Shop Fabrication Roll Grooving Tools

VE268

[Download publication 24.01](#) for complete information

- Roll grooves ¾–12" | DN20–DN300 pipe
- For grooving of Schedule 5, 10, 40 and 80 steel; stainless steel; aluminum and PVC pipe. K, L, M and DWV copper tube.
- The fully-motorized, semi-automatic, electrohydraulic tool comes complete with safety guards and safety foot switch
- Equipped with a unique pivot arm design, making roll changes quick and easy, without removing shafts
- Enhanced tracking rolls help to keep the pipe on the tool during the roll grooving process
- Power Requirements: 220/440 volt, 3-phase, 60 hertz standard; the tool can also be supplied in various voltages, contact Victaulic for details
- 3-phase requires tool power to be hard wired by a local certified electrician
- Weight: 735 lbs. | 333 kg



Plant/Shop Fabrication Roll Grooving Tools

RG5200i

[Download publication 24.05](#) for complete information

- Fully-automated, hydraulic shop tool is shipped fully assembled with proximity scanner, control stand and rolls for standard grooving (4–24" | DN100–DN600) Schedule 40 pipe
- Enhanced tracking rolls help to keep the pipe on the tool during the roll grooving process
- Tool ships with 4–12" | DN100–DN300 Original Groove System Groove Rolls and 14–24" | DN350–DN600 AGS Groove Rolls
- Drive Requirements: Self-contained
- Power Requirements: 208/240 volt, 3 phase, 50/60 hertz standard. The tool can also be supplied for use with various global voltage connections, contact Victaulic for details.
- 3 phase requires tool power to be hard wired by a local certified electrician.
- Weight: 1120 lbs. | 508 kg



Field Fabrication Cut Grooving Tools

VG28GD (GEAR DRIVE)

[Download publication 24.01](#) for complete information

- Cut grooves 2–8" | DN50–DN200 pipe
- For grooving of Schedule 40 through 80 steel; stainless steel and aluminum pipe; Class 53 Min ductile iron
- VG28GD will produce a single OGS cut groove for unlined piping systems
- Designed to be driven by the Power Mule II
- Drive Requirements: External drive, min. 1½ hp | 1.12 kw
- Drive Speed: 38 rpm max.
- Weight: 37 lbs. | 17 kg



Field Fabrication Cut Grooving Tools

VG VIC-GROOVER

[Download publication 24.01](#) for complete information

- Cut grooves ¾–8" | DN20–DN200 pipe
- For grooving of Schedule 40 through 80 steel; stainless steel; aluminum and PVC pipe; Class 53 Min ductile iron
- Designed for manual or power cut grooving
- Supplied with a ratchet handle for manual operation
- Drive Requirements: Manual or external drive, min. ½ hp | 0.37 kw
- External power drives must meet all safety conditions
- Drive Speed: 40 rpm max.
- Weight: 28 lbs. | 13 kg

Pipe Preparation Tools



Vic-Press™ Tools

PFT510

[Download publication 24.01](#) for complete information

- Designed for securing *Vic-Press* Schedule 10S products onto Schedule 10S stainless steel pipe
- Tool package includes:
 - (1) PFT510 tool,
 - (2) 18V Lithium Ion batteries,
 - (1) battery charger,
 - (1) tool carrying case,
 - (1) jaw carrying case,
 - (1) each of jaws sized ½" | DN15, ¾" | DN20, 1" | DN25, 1½" | DN40, and 2" | DN50, and
 - (1) adapter jaw
- Not compatible with PFT505 and/or PFT509 tools/components
- Power Requirements: Battery pack 110volt, 60cycle, 6.5 amp (optional 220volt)
- Weight: 21 lbs. | 9.5 kg (PFT510 with 1" | DN25 jaw)

Certifications/Listings:



Hole Cutting Tools

HCT908

[Download publication 24.01](#) for complete information

- One-piece hole cutting tool designed to cut holes up to 4½" | 120mm in carbon and stainless steel pipe; for pipe sizes up to 8" | DN200
- Allows use of *Mechanical-T*, *Vic-Let*, and *Vic-O-Well* outlets
- Power Requirements: 110 volt, single phase, 60 hertz, 7 amp
- Weight: 23 lbs. | 10 kg



Hole Cutting Tools

VHCT900

[Download publication 24.01](#) for complete information

- Three-piece hole cutting tool designed to cut holes up to 3½" | 90 mm in diameter for *Mechanical-T*, *Vic-Let*, and *Vic-O-Well* outlets
- Base unit clamps quickly onto the pipe in vertical, horizontal or overhead positions
- Available extended chain for 10–24" | DN250–DN600 pipe
- Power Requirements: Grounded 120 volt, single phase, 60 hertz, 10 amp electrical supply (220 volt, single phase, 60 hertz, 5 amp available on request)
- Weight: 36 lbs. | 16 kg



Hole Cutting Tools

VIC-TAP II

[Download publication 24.01](#) for complete information

- Hole cutting tool including Style 931 *Vic-Tap II Mechanical-T* unit for tapping into steel pipe systems under pressure up to 500 psi | 3447 kPa | 34 bar
- Hole size 2¾" | 60.5 mm
- Power Requirements: 115 volt, single phase, 60 hertz, 7.5 amp
- Weight:
Drill guide base: 15 lbs. | 6.8 kg; Drill motor and feed assembly: 16 lbs. | 7.3 kg; Style 931 valve unit, 12–15 lbs. | 5.4–6.8 kg, depending upon size (4" | DN100, 5" | 141.3 mm, 6" | DN150 and 8" | DN200 available)
- Standard Capability: 4–8" | DN100–DN200
Run outlet only × 2½" | 73.0 mm (IPS) Outlet

Pipe Preparation Tools



Tool Accessories

VPD752 POWER DRIVE

[Download publication 24.01](#) for complete information

- Can be used as the power drive unit for the VE226, VE26, VE206, VE46, VE416FS and VE272SFS roll grooving tools provided each tool is equipped with the correct base plate and the VG, VG28GD, and VG824 tools, with universal drive shaft
- Operated with a safety foot switch
- Power Requirements: 115 volts, 15 amp, 50/60 hertz (220 volt, 6 amp, 50/60 cycle option)
- Weight: 140 lbs. | 634 kg



Tool Accessories

POWER MULE II

[Download publication 24.01](#) for complete information

- Ideal for driving individual Victaulic® cut grooving tools
- Heavy-duty, two wheeled unit drives Victaulic cut grooving tools at the speed/power necessary for accurate grooving
- Rotating head for horizontal and vertical applications
- Power Mule II equipped with forward-off-reverse control and integral safety foot switch
- Full load speed: 35 rpm
- Power Requirements: 115 volts, 15 amp, 50/60 cycle (220 volts optional)
- Weight: 190 lbs. | 86 kg



Tool Accessories

VAPS112 ADJUSTABLE PIPE STAND

[Download publication 24.01](#) for complete information

- Designed for supporting pipe to be roll grooved
- Turnstile design allows pipe to be spun around for grooving of both pipe ends without dismounting pipe from stand
- Forward/traverse movement
- Capacity: $\frac{3}{4}$ –12" | DN20–DN300 pipe
- Load rating: 1,075 lbs. | 490 kg
- Vertical stroke: The legs adjust from 8½" | 216 mm to achieve table height of 23" | 584 mm
- Minimum pipe height from floor:
23" | 584 mm on 12" | DN300 pipe and
21" | 533 mm on 1" | DN25 pipe
- Weight: 190 lbs. | 86 kg

Design Data

Introduction

This Victaulic® Fire Protection Catalog provides general information on mechanical piping methods and Victaulic products for fire protection systems. For the latest and most up-to-date information, always consult the individual product submittals provided on the Victaulic web site – victaulic.com. This catalog is organized to provide information in the context and form most readily usable. For easy identification of major sections of interest, see the condensed table of contents on pg. i, for a fully detailed index, see pg. 88. For more detailed design guidelines, consult Design Data, [Publication 26.01](#).

Important Information

Victaulic standard grooved pipe couplings are designed for use with pipe grooved to meet Victaulic groove specifications and Victaulic grooved end fittings, valves, and related grooved end components only. They are not intended for use with plain end pipe and/or fittings. Victaulic plain end couplings are designed for use only with plain end or beveled end steel pipe (unless otherwise indicated) and Victaulic plain end fittings. **Victaulic plain end couplings must not be used with grooved end threaded pipe and/or fittings.**

Pipe must be prepared to meet Victaulic specifications outlined for each specific product style. Performance data listed herein is based on proper pipe preparation. The proper gasket must be selected for the service intended. **It should be noted that there are various services for which Victaulic gaskets are not recommended. Reference should always be made to the latest Victaulic Gasket Selection Guide (request [Publication 05.01](#)) for specific gasket service recommendations and for a listing of services which are not recommended. Gaskets for Victaulic products always must be lubricated for proper assembly.** Gasket lubricant must meet manufacturer's specifications. Thorough lubrication of the gasket exterior, when required, including the lips and/or pipe ends and housing interiors, is essential to prevent gasket pinching. Lubrication assists proper gasket seating and alignment during installation.

Victaulic FireLock™ devices require proper set up and maintenance. Always refer to the latest manual included with each valve for details.

When installing *Victaulic FireLock* automatic sprinklers it is important to select the proper wrench for installation. A complete guide for proper installation of Victaulic automatic sprinklers is available by requesting [Publication I-40](#).

Victaulic has a complete line of tools for preparing pipe to Victaulic specifications. Use of these tools is recommended in preparing pipe to receive Victaulic products. Always read and understand the Tool Operating Instructions supplied with every Victaulic tool prior to using any tools. All data contained herein, is subject to change without notice.

Notice

The technical and performance data, weights, dimensions and specifications published are current as of the date of publication. For the most up-to-date information visit the Victaulic web site for detailed specific product submittal information.

Victaulic maintains a policy of continual product improvement and, therefore, reserves the right to change product specifications, designs, and standard equipment without notice and without incurring obligation.

For the most up-to-date Victaulic product information, please visit victaulic.com.

The material presented in this catalog is intended for piping design reference in utilization of Victaulic products for their intended application. It is not intended as a substitute for competent, professional assistance which is an obvious requisite to any specific application.

Design

Reference should always be made to design information available at no charge on request from Victaulic. Good piping practices should always prevail. Specific pressures, temperatures, external or internal loads, performance standards and tolerances must never be exceeded. Many applications require recognition of special conditions, code requirements and use of safety factors. Qualified engineers must make these decisions.

While every effort has been made to ensure its accuracy, Victaulic, its subsidiaries and affiliated companies, make no express or implied warranty of any kind respecting the information contained in this catalog or the material referred to herein.

Anyone making use of the information or material contained herein does so at their own risk and assumes any and all liability resulting from such use.

Installation

Reference should always be made to the specific Victaulic® Field Installation Handbook for the product you are installing. The following is a list of handbooks that can be requested for free from Victaulic:

Handbooks are included with each shipment of Victaulic products for complete installation and assembly data, and are available in PDF format on our website at victaulic.com.

Warranty:

We warrant all products to be free from defects in materials and workmanship under normal conditions of use and service. Our obligation under this warranty is limited to repairing or replacing at our option at our factory any product which shall within one year after delivery to original buyer be returned with transportation charges prepaid, and which our examination shall show to our satisfaction to have been defective.

THIS WARRANTY IS MADE EXPRESSLY IN LIEU OF ANY OTHER WARRANTIES, EXPRESS OR IMPLIED, INCLUDING ANY IMPLIED WARRANTY OF MERCHANTABILITY OR FITNESS FOR A PARTICULAR PURPOSE. THE BUYER'S SOLE AND EXCLUSIVE REMEDY SHALL BE FOR THE REPAIR OR REPLACEMENT OF DEFECTIVE PRODUCTS AS PROVIDED HEREIN. THE BUYER AGREES THAT NO OTHER REMEDY (INCLUDING, BUT NOT LIMITED TO, INCIDENTAL OR CONSEQUENTIAL DAMAGES FOR LOST PROFITS, LOST SALES, INJURY TO PERSON OR PROPERTY OR ANY OTHER INCIDENTAL OR CONSEQUENTIAL LOSS) SHALL BE AVAILABLE TO HIM.

Victaulic neither assumes nor authorizes any person to assume for it any other liability in connection with the sale of such products.

This warranty shall not apply to any product which has been subject to misuse, negligence or accident, which has been repaired or altered in any manner outside of a Victaulic factory or which has been used in a manner contrary to Victaulic instructions or recommendations. Victaulic shall not be responsible for design errors due to inaccurate or incomplete information supplied by Buyer or its representatives.

Items purchased by Victaulic and resold will have the original equipment manufacturer's warranty extended to Victaulic customers.

Design Data

Rounded Inches Decimal Equivalent Per Foot

¼ = .02	¾ = .27	6¼ = .52	9¼ = .77
½ = .04	3½ = .29	6½ = .54	9½ = .79
¾ = .06	3¾ = .31	6¾ = .56	9¾ = .81
1 = .08	4 = .33	7 = .58	10 = .83
1¼ = .10	4¼ = .35	7¼ = .60	10¼ = .85
1½ = .125	4½ = .375	7½ = .625	10½ = .875
1¾ = .15	4¾ = .40	7¾ = .65	10¾ = .90
2 = .17	5 = .42	8 = .67	11 = .92
2¼ = .19	5¼ = .44	8¼ = .69	11¼ = .94
2½ = .21	5½ = .46	8½ = .71	11½ = .96
2¾ = .23	5¾ = .48	8¾ = .73	11¾ = .98
3 = .25	6 = .50	9 = .75	12 = 1.00

Right Triangle Formula

$$c^2 = a^2 + b^2$$

$$A = B - 90^\circ$$

$$B = A - 90^\circ$$

$$A + B + C = 180^\circ$$

$$\sin A = \frac{a}{c}$$

$$\cos A = \frac{b}{c}$$

$$\tan A = \frac{a}{b}$$

$$\sin B = \frac{b}{c}$$

$$\cos B = \frac{a}{c}$$

$$\tan B = \frac{b}{a}$$

Hydraulic Formula

$$Q = K\sqrt{P}$$

$$K = \frac{Q}{\sqrt{P}}$$

$$P = \left(\frac{Q}{K}\right)^2$$

$$[H = E \times .433]$$

Q = Flow
P = Pressure
K = K-factor
E = Elevation in feet
H = Head
.433 = Water specific density

Sizing Air Compressor in CFM

$$\frac{VP}{(7.48)(14.7)(T)} = \text{CFM's required}$$

V = Gallons
P = Pressure (psi)
7.48 = Gallons ft³

14.7 = Atmospheric pressure
T = Time (minutes)

Triangle Offset Formulas

45° Offset

$$B = A (.707)$$

$$A = B (1.414)$$

Example:
B = 6"
A = 6" × 1.414
A = 8.484"

"Rolling Offset"

$$C = \sqrt{A^2 + B^2}$$

Example:
C = √9' + 4'
C = 3.60'

Imperial (U.S.)/Metric Conversion Chart

This chart is provided as a guide for converting imperial and metric measurements provided within this catalog.

Convert Imperial (U.S.) to Metric		⇔	Convert Metric to Imperial (U.S.)			
25.4	×	Inches (In.)	⇔	Millimeters (mm)	×	0.03937
0.3048	×	Feet (Ft.)	⇔	Meters (m)	×	3.281
0.4536	×	Pounds (Lbs.)	⇔	Kilograms (kg)	×	2.205
28.35	×	Ounces (Oz.)	⇔	Grams (g)	×	0.03527
6.894	×	Pressure (psi)	⇔	Kilopascals (kPa)	×	0.145
0.069	×	Pressure	⇔	Bar	×	14.5
4.45	×	End Load (Lbs.)	⇔	Newtons (N)	×	0.2248
1.356	×	Torque (Lb. Ft.)	⇔	Newton Meters (N•m)	×	0.738
F - 32 ÷ 1.8		Temp.(°F)	⇔	Celsius (°C)		C + 17.78 × 1.8
745.7	×	Horsepower (hp)	⇔	Watts (w)	×	1.341 × 10 ⁻³
3.785	×	Gal. per Min. (GPM)	⇔	Liters per Min. (L/M)	×	0.2642
3.785	×	10 ⁻³ Gal. per Min. (GPM)	⇔	Cubic Meters per Min. (m ³ /m)	×	264.2
1.44	×	K-factor (Imperial)	⇔	K-factor (SI)	×	0.69

Index

VicFlex™ Sprinkler Fitting System

Series AH1	3
Series AH2	2
Series AH2-CC	2
Series AH2-300	2
Series AH5	3
Series AQD	8
Series AQC-U	8
Style AB1	3
Style AB2	4
Style AB3	7
Style AB4	4
Style AB5	4
Style AB6	7
Style AB7	5
Style AB7 Adjustable	5
Style AB8	5
Style AB10	6
Style AB11	6
Style AB12	6
Style VS1	7
VicFlex Reducer Nipples and Elbows	8

Couplings

AGS Flexible Coupling	13
FireLock EZ™ Rigid Coupling	11
FireLock™ Flange Adapter	16
FireLock Rigid Coupling	11
Flexible Couplings	12–13
High Pressure Rigid Coupling	14
Outlet Coupling	14
Plain End Installation-Ready™ Refuse-to-Fuse™ Coupling for HDPE Pipe	15
QuickVic™ Flexible Coupling	12
QuickVic Rigid Coupling	11
Reducing Coupling	13
Refuse-to-Fuse Coupling for HDPE-to-Steel Pipe	15
Rigid Coupling for Type 316 Stainless Steel	14
Vic-Boltless Coupling and Tool	15
Vic-Flange Adapters	16
Zero-Flex™ Rigid Coupling	12

Fittings

Drain Elbow	18
FireLock Fittings	18
FireLock Installation-Ready Fittings	18
Standard Grooved End Fittings	19
Vic™-End II End of Run Elbow	19

Innovative Groove System (IGS)

FireLock IGS Fittings and Adapters	24
FireLock IGS Installation-Ready Fittings	22
FireLock IGS Installation-Ready Rigid Coupling	22
FireLock IGS Outlet-T	23
FireLock IGS Welded Outlet	23

Hole Cut Systems

FireLock Low Profile Sprinkler Tee– EMEA only	26
FireLock Outlet-T Mechanical-T Bolted Branch Outlet and Cross Assemblies	26
Vic-Let Strapless Outlet	26

Valves and Accessories

Brass Body Ball Valve — Threaded	31
FireLock Ball Valve	31
FireLock Butterfly Valve– Supervised Closed	28
FireLock Butterfly Valve– Supervised Open	28
FireLock Check Valve	29
FireLock Commercial Zone Control Riser Module	32
FireLock High Pressure Butterfly Valve– Supervised Closed	29
FireLock High Pressure Butterfly Valve– Supervised Open	28
FireLock High Pressure Check Valve	29
FireLock High Pressure Riser Check Valve	30

FireLock NRS Gate Valves	31
FireLock OS&Y Gate Valves	30
FireLock Residential Zone Control Riser Module	32
FireLock Riser Check Valve	30
FireLock Upright Post Indicator	33
FireLock Wall Post Indicator	33
FireLock Wye Type Vic-Strainer	34
Fire Pump Test Meter	34
TestMaster™ II Alarm Test Module	33

Devices and Accessories

Accessories Compatibility Chart	40
Air Maintenance/ Compressor Assembly	41
AutoConvert Assembly	38
Double Pneumatic Actuator	42
Electric/Pneumatic Double Interlock Actuator	41
FireLock Air Maintenance Trim Assembly	44
FireLock Alarm Check Valve	39
FireLock Auto Drain	42
FireLock Ball Check Valve	42
FireLock Dry Accelerator	43
FireLock European Alarm Check Valve Station	39
FireLock Fire-Pac	38
FireLock NXT Alternate Wet/Dry System Check Valve–Europe Only	39
FireLock NXT Deluge Check Device	37
FireLock NXT™ Dry Check Device	37
FireLock NXT Preaction Check Device	37
FireLock Retard Chamber	43
Low Pressure Actuator	41
Manual Release Panel	43
Supplemental Alarm Kit	44
Water Column Drain Kit	44
Water Motor Alarm	45

Hydraulic Control Valves

Level Control Valves Series 866-460	48
Series 866-465	48
Series 866-466	48
Series 866-480	49
Series 866-482	49
Pressure Control Valves Series 867-4UF	51
Series 867-400	50
Series 867-42T	49
Series 867-43T	50
Series 867-459	52
Series 867-7UF	51
Series 867-7UL	50
Series 867-759	51

Sprinklers and Accessories

Accessories	66
Dry	63–64
Extended Coverage	57–58
Nozzles	65
Residential	61
Specific Application	62
Standard Commercial	55–56
Storage	59–60
Wrenches	66

Victaulic Vortex™

Victaulic Vortex 500 Fire Suppression System	68
Victaulic Vortex 1000 Fire Suppression System	68
Victaulic Vortex 1500 Fire Suppression System	68

Specialty Systems

AWWA Piping Systems for North America	72
Copper Piping System	71
Plain End Piping System	70
The Refuse-to-Fuse System for HDPE Pipe	71
Stainless Steel Piping System	72
Vic-Press™ for Schedule 10S Stainless Steel Piping	70

Index

Pipe Preparation Tools

HCT908	81
PFT510	81
Power Mule II	83
RG2100	78
RG5200i	79
Style VE206	76
VAPS112 Adjustable Pipe Stand	84
VE106/VE107 Groove-N-Go	76
VE12 Groove In-Place	74
VE26 Groove In-Place	74
VE46 Groove In-Place	75
VE226 Portable Groover	75
VE268	79
VE270FSD/VE271FSD	77
VE272SFS	77
VE416FSD/VE417FSD	78
VG <i>Vic-Groover</i>	80
VG28GD (Gear Drive)	80
VHCT900	82
<i>VIC-TAP II</i>	82
VPD752 Power Drive	83

PRODUCT CERTIFICATIONS:

Fire Protection

ACTIVFIRE – ActivFire Register of Fire Protection Equipment (Australia)
CCCFC – China Certification Center for Fire Protection Products (China)
CFPSC – Chinese Fire Protection Safety Center (Taiwan)
CNBOP – Centrum Naukowo-Badawcze Ochrony Przeciwpozarowej (Poland)
CNPP- Centre National de Prévention et de Protection (France)
CTPC – Consiliul Technic Permanent Pentru Constructii (Romania)
cULus – Underwriter’s Laboratories, LLC (USA)
EMI – Epitesugyi Minosegellenorzo Innovacious (Hungary)
FDNY – City of New York Fire Department (USA)
FM – FM Approvals (USA)
HDB – Singapore Housing Development Board (Singapore)
KFI – Korea Fire Industry Technology Institute (Korea)
LPCB – Loss Prevention Certification Board (UK)
SBSC – Svensk Brand & Säkerhets Certifiering AB (Sweden)
TFRI – Tanjin Fire Research Institute of Ministry of Public Security (China)
TSU – Technický Skúšobný Ústav Piešťany, š.p. (Slovakia)
TSUS – Technický Skúšobný Ústav Stavebný, n.o. (Slovakia)
TZUS – Technický a Zkušební Ústav Stavební Praha, s.p. (Czech Republic)
UKRFIRECERT – State Certification Center (Ukraine)
UL – Underwriter’s Laboratories, LLC (USA)
ULC – Underwriter’s Laboratories of Canada (Canada)
VdS – Verband der Schadenverhütung GmBH (Germany)
VKF – Vereinigung Kantonaler Feuerversicherungen (Switzerland)
Zagrebinspekt (Croatia)

Potable Water

ÁNTSZ – Állami Népegészségügyi És Tisztiorvosi Szologálat (Hungary)
ARPA – Agenzia Regionale per la Protezione dell’Ambiente (Italy)
DVGW – Deutscher Verein des Gas- und Wasserfaches e.V. (Germany)
Eurofins – ACS : Attestation de Conformité Sanitaire (France)
HZJZ – Croatian National Institute of Public Health (Croatia)
NSF – NSF International (USA)
ÖVGW – Österreichische Vereinigung für das Gas- und Wasserfach (Austria)
PZH – Panstwowy Zaklad Higieny (Poland)
RUVZPP – Regionálny úrad verejného zdravotníctva so sídlom v Poprade (Slovakia)
SAI – SAI Global (Australia)
SPAN – Suruhanjaya Perkhidmatan Air Negara (Malaysia)
SVGW – Schweizerischer Verein des Gas- und Wasserfaches (Sweden)
UL – Underwriter’s Laboratories, LLC (USA)
WRAS – Water Regulations Advisory Scheme (UK)
ZUOVA – ZDRAVOTNÍ ÚSTAV se sídlem v Ostrave (Czech Republic)

Maritime

ABS – American Bureau of Shipping (USA)
BV – Bureau Veritas (France)
CCG – Canadian Coast Guard (Canada)
CRS – Croatian Register of Shipping (Croatia)
CCS – China Classification Society (China)
DNV – Det Norske Veritas (Norway)
DNV GL (Global)
GL – Germanischer Lloyd (Germany)
KRS – Korean Registry of Shipping (Korea)
LR – Lloyd’s Register of Shipping (UK)
RINA – Registro Italiano Navale (Italy)
USCG – US Coast Guard (USA)

HVAC

CSTB – Centre Scientifique et Technique du Bâtiment (France)
ITB – Instytut Techniki Budowlanej (Poland)
Sercons Europe BV (Russia)
Plumbing
IAPMO – International Association of Plumbing & Mechanical Officials (USA)
ICC-ES – International Code Council- Evaluation Service (USA)
NSF – NSF International (USA)
WaterMark (Australia)

COMPLIANCE:

Codes/Standards

ANSI – American National Standards Institute (USA)
API – American Petroleum Institute (USA)
APSAD – Assemblée Plénière Société Assurance Dommage (France)
AS/NZS – Standards Australia and Standards New Zealand (AU & NZ)
ASTM – American Society for Testing and Materials (USA)
AWWA – American Water Works Association (USA)
BOCA – Building Officials and Code Administrators (USA)
CSA – Canadian Standards Association (Canada)
CSFM – California State Fire Marshal (USA)
EN – European Standards
GOST R – Gosstandart (Russia)
IPC – International Plumbing Code (USA)
ISO – International Standards Organization (Global)
NACE – National Association of Corrosion Engineers (USA)
NFPA – National Fire Protection Association (USA)
SBCCI – Southern Building Code Congress International (USA)
UPC – Uniform Plumbing Code (USA)

Pressure Equipment Safety

(97/23/EC) PED – Pressure Equipment Directive (Europe)
CSA B51 – “Boiler, Pressure Vessel, and Pressure Piping Code” (Canada)
CRN – Canadian Registration Number per CSA B51 (Canada)

Chemical Safety / Recycling

(EC/1907/2006) REACH– Registration, Evaluation, Authorization, and Registration of Chemicals (Europe)
(2002/95/EC) RoHS – Restriction of Hazardous Substances Directive (Europe)
(2002/96/EC) WEEE – Waste Electrical and Electronic Equipment Directive (Europe)

Building Services

(EU/305/2011) CPR – Construction Products Regulation-Fire safety products (Europe)
NBC – National Building Code (Canada)
PSB – TUV SUD PSB Singapore (Singapore)

Explosive Environments

(94/9/EC) ATEX – Equipment and protective systems for potentially explosive atmospheres (Europe)
--

Seismic

OSHPD – Office of Statewide Health Planning and Development (USA)

Tools and Machinery

(2006/42/EC) MD – Machinery Directive (Europe)
--

© Copyright 2017, Victaulic® Company. All rights reserved.

No part of this Victaulic catalog may be reproduced, stored in a retrieval system, or transmitted, in any form or by any means, electronic, mechanical, photocopy, recording or otherwise, without the prior written permission of Victaulic Company.

VICTAULIC® WORLDWIDE

North and South America

UNITED STATES AND WORLD HEADQUARTERS

4901 Kesslersville Road
Easton, PA 18040 USA
1 800 PICK VIC
1 800 742 5842
(within North America)
1 610 559 3300
pickvic@victaulic.com

CANADA

123 Newkirk Road
Richmond Hill
Ontario L4C 3G5 Canada
1 905 884 7444
viccanada@victaulic.com

MEXICO

Calle Circuito del Marqués
No 8 al 11
Parque Industrial El Marqués
Municipio El Marqués
Queretaro, Mexico
CP 76246
52 442 253 0066
vical@victaulic.com

BRAZIL

Av. Marquês de São Vicente
446 Cj 1303
Várzea da Barra Funda –
São Paulo-SP
CEP 01139-000 – Brazil
55 11 3548 4280
vicbr@victaulic.com

Europe, Middle East, Africa and India

BELGIUM EUROPE HEADQUARTERS

Prijkelstraat 36
9810 Nazareth, Belgium
32 9 381 15 00
49 6151 737 79 70
(within Germany)
viceuro@victaulic.com

UNITED KINGDOM

Units B1 & B2, SG1 Industrial Park
Cockerell Close, Gunnels Wood Road
Stevenage, Hertfordshire, UK
SG 1 2NB
44 1438 310 690
viceuro@victaulic.com

UNITED ARAB EMIRATES

FZ LIU10 AA01, AA02, AA03,
AA04 and AA05
Al Munawala Street
Jebel Ali Freezone – Southzone
PO BOX 17683
Jebel Ali, Dubai
UAE-United Arab Emirates
971 4 883 88 70
viceuro@victaulic.com

INDIA

India Land Global Industrial Park
Plot 4, Hinjewadi, Phase-1, Mulshi
Pune 411057, India
91 20 67 919 300
viceuro@victaulic.com

Asia Pacific

CHINA

Unit 808, Building B
Hongwell International Plaza
No.1602 West Zhongshan Road
Shanghai, China 200235
86 21 6021 9400
vicap@victaulic.com

KOREA

1F, BH Building, 18-gil 5, Bangbae-ro
Seocho-gu
Seoul, 06664, Rep. of Korea
82 2 521 7235
vicap@victaulic.com
cc.korea@victaulic.com

TAIWAN

No. 55, NanGong Rd, LuZhu District
TaoYuan City 338, Taiwan
886 3 222 3220
vicap@victaulic.com

AUSTRALIA AND NEW ZEALAND

7 Chambers Road
Unit 1
Altona North, Victoria
Australia 3025
1 300 PIC VIC
1 300 742 842
(within Australia)
0 508 PICK VIC
0 508 7425 842
(within New Zealand)
61 3 9392 4000
vicaust@victaulic.com

For additional locations, information and support, visit www.victaulic.com/contactus

victaulic.com



G-105 3567 REV H 10/2017

Victaulic and all other Victaulic marks are the trademarks or registered trademarks of Victaulic Company, and/or its affiliated entities, in the U.S. and/or other countries. All other trademarks listed herein are the property of their respective holders, in the U.S. and/or other countries. The terms "Patented" or "Patent Pending" refer to design or utility patents or patent applications for articles and/or methods of use in the United States and/or other countries.

© 2017 VICTAULIC COMPANY. ALL RIGHTS RESERVED.

